

## User's Manual



## *System 4xi Series*

System 4LQxi • Switcher/Line Quadrupler  
System 4LDxi • Switcher/Line Doubler

# Precautions

## Safety Instructions • English



This symbol is intended to alert the user of important operating and maintenance (servicing) instructions in the literature provided with the equipment.



This symbol is intended to alert the user of the presence of uninsulated dangerous voltage within the product's enclosure that may present a risk of electric shock.

### Caution

**Read Instructions** • Read and understand all safety and operating instructions before using the equipment.

**Retain Instructions** • The safety instructions should be kept for future reference.

**Follow Warnings** • Follow all warnings and instructions marked on the equipment or in the user information.

**Avoid Attachments** • Do not use tools or attachments that are not recommended by the equipment manufacturer because they may be hazardous.

## Consignes de Sécurité • Français



Ce symbole sert à avertir l'utilisateur que la documentation fournie avec le matériel contient des instructions importantes concernant l'exploitation et la maintenance (réparation).



Ce symbole sert à avertir l'utilisateur de la présence dans le boîtier de l'appareil de tensions dangereuses non isolées posant des risques d'électrocution.

### Attention

**Lire les instructions** • Prendre connaissance de toutes les consignes de sécurité et d'exploitation avant d'utiliser le matériel.

**Conservier les instructions** • Ranger les consignes de sécurité afin de pouvoir les consulter à l'avenir.

**Respecter les avertissements** • Observer tous les avertissements et consignes marqués sur le matériel ou présentés dans la documentation utilisateur.

**Eviter les pièces de fixation** • Ne pas utiliser de pièces de fixation ni d'outils non recommandés par le fabricant du matériel car cela risquerait de poser certains dangers.

## Sicherheitsanleitungen • Deutsch



Dieses Symbol soll den Benutzer auf wichtige Anleitungen zur Bedienung und Wartung (Instandhaltung) in der Dokumentation hinweisen, die im Lieferumfang dieses Gerätes enthalten ist.



Dieses Symbol soll den Benutzer darauf aufmerksam machen, daß im Inneren des Gehäuses dieses Produktes gefährliche Spannungen, die nicht isoliert sind und die einen elektrischen Schock verursachen können, herrschen.

### Achtung

**Lesen der Anleitungen** • Bevor Sie das Gerät zum ersten Mal verwenden, sollten Sie alle Sicherheits- und Bedienungsanleitungen genau durchlesen und verstehen.

**Aufbewahren der Anleitungen** • Die Sicherheitsanleitungen sollten aufbewahrt werden, damit Sie später darauf zurückgreifen können.

**Befolgen der Warnhinweise** • Befolgen Sie alle Warnhinweise und Anleitungen auf dem Gerät oder in der Benutzerdokumentation.

**Keine Zusatzgeräte** • Verwenden Sie keine Werkzeuge oder Zusatzgeräte, die nicht ausdrücklich vom Hersteller empfohlen wurden, da diese eine Gefahrenquelle darstellen können.

## Instrucciones de seguridad • Español



Este símbolo se utiliza para advertir al usuario sobre instrucciones importantes de operación y mantenimiento (o cambio de partes) que se desean destacar en el contenido de la documentación suministrada con los equipos.



Este símbolo se utiliza para advertir al usuario sobre la presencia de elementos con voltaje peligroso sin protección aislante, que puedan encontrarse dentro de la caja o alojamiento del producto, y que puedan representar riesgo de electrocución.

### Precaucion

**Leer las instrucciones** • Leer y analizar todas las instrucciones de operación y seguridad, antes de usar el equipo.

**Conservar las instrucciones** • Conservar las instrucciones de seguridad para futura consulta.

**Obedecer las advertencias** • Todas las advertencias e instrucciones marcadas en el equipo o en la documentación del usuario, deben ser obedecidas.

**Evitar el uso de accesorios** • No usar herramientas o accesorios que no sean específicamente recomendados por el fabricante, ya que podrían implicar riesgos.

### Warning

**Power sources** • This equipment should be operated only from the power source indicated on the product. This equipment is intended to be used with a main power system with a grounded (neutral) conductor. The third (grounding) pin is a safety feature, do not attempt to bypass or disable it.

**Power disconnection** • To remove power from the equipment safely, remove all power cords from the rear of the equipment, or the desktop power module (if detachable), or from the power source receptacle (wall plug).

**Power cord protection** • Power cords should be routed so that they are not likely to be stepped on or pinched by items placed upon or against them.

**Servicing** • Refer all servicing to qualified service personnel. There are no user-serviceable parts inside. To prevent the risk of shock, do not attempt to service this equipment yourself because opening or removing covers may expose you to dangerous voltage or other hazards.

**Slots and openings** • If the equipment has slots or holes in the enclosure, these are provided to prevent overheating of sensitive components inside. These openings must never be blocked by other objects.

**Lithium battery** • There is a danger of explosion if battery is incorrectly replaced. Replace it only with the same or equivalent type recommended by the manufacturer. Dispose of used batteries according to the manufacturer's instructions.

### Avertissement

**Alimentations** • Ne faire fonctionner ce matériel qu'avec la source d'alimentation indiquée sur l'appareil. Ce matériel doit être utilisé avec une alimentation principale comportant un fil de terre (neutre). Le troisième contact (de mise à la terre) constitue un dispositif de sécurité : n'essayez pas de le contourner ni de le désactiver.

**Déconnexion de l'alimentation** • Pour mettre le matériel hors tension sans danger, déconnectez tous les cordons d'alimentation de l'arrière de l'appareil ou du module d'alimentation de bureau (s'il est amovible) ou encore de la prise secteur.

**Protection du cordon d'alimentation** • Acheminer les cordons d'alimentation de manière à ce que personne ne risque de marcher dessus et à ce qu'ils ne soient pas écrasés ou pincés par des objets.

**Réparation-maintenance** • Faire exécuter toutes les interventions de réparation-maintenance par un technicien qualifié. Aucun des éléments internes ne peut être réparé par l'utilisateur. Afin d'éviter tout danger d'électrocution, l'utilisateur ne doit pas essayer de procéder lui-même à ces opérations car l'ouverture ou le retrait des couvercles risquent de l'exposer à de hautes tensions et autres dangers.

**Fentes et orifices** • Si le boîtier de l'appareil comporte des fentes ou des orifices, ceux-ci servent à empêcher les composants internes sensibles de surchauffer. Ces ouvertures ne doivent jamais être bloquées par des objets.

**Lithium Batterie** • Il y a danger d'explosion s'il y a un remplacement incorrect de la batterie. Remplacer uniquement avec une batterie du même type ou d'un type équivalent recommandé par le constructeur. Mettre au rebut les batteries usagées conformément aux instructions du fabricant.

### Vorsicht

**Stromquellen** • Dieses Gerät sollte nur über die auf dem Produkt angegebene Stromquelle betrieben werden. Dieses Gerät wurde für eine Verwendung mit einer Hauptstromleitung mit einem geerdeten (neutralen) Leiter konzipiert. Der dritte Stift oder Kontakt ist für einen Erdschluß, und stellt eine Sicherheitsfunktion dar und sollte nicht umgangen oder außer Betrieb gesetzt werden.

**Stromunterbrechung** • Um das Gerät auf sichere Weise vom Netz zu trennen, sollten Sie alle Netzkabel aus der Rückseite des Gerätes oder aus dem Desktop-Strommodul (falls dies möglich ist) oder aus der Wandsteckdose ziehen.

**Schutz des Netzkabels** • Netzkabel sollten stets so verlegt werden, daß sie nicht im Weg liegen und niemand darauf treten kann oder Objekte darauf- oder unmittelbar dagegen gestellt werden können.

**Wartung** • Alle Wartungsmaßnahmen sollten nur von qualifiziertem Servicepersonal durchgeführt werden. Im Inneren des Gerätes sind keine Teile enthalten, die vom Benutzer gewartet werden können. Zur Vermeidung eines elektrischen Schocks versuchen Sie in keinem Fall, dieses Gerät selbst zu warten, da beim Öffnen oder Entfernen der Abdeckungen die Gefahr eines elektrischen Schlags oder andere Gefahren bestehen.

**Schlitze und Öffnungen** • Wenn das Gerät Schlitze oder Löcher im Gehäuse aufweist, dienen diese zur Vermeidung einer Überhitzung der empfindlichen Teile im Inneren. Diese Öffnungen dürfen niemals von anderen Objekten blockiert werden.

**Litium-Batterie** • Explosionsgefahr, falls die Batterie nicht richtig ersetzt wird. Ersetzen Sie nur durch die gleiche oder einen vergleichbaren Batterietyp, der auch vom Hersteller empfohlen wird. Entsorgung der verbrauchten Batterien bitte gemäß den Herstelleranweisungen.

### Advertencia

**Alimentación eléctrica** • Este equipo debe conectarse únicamente a la fuente/tipo de alimentación eléctrica indicada en el mismo. La alimentación eléctrica de este equipo debe provenir de un sistema de distribución general con conductor neutro a tierra. La tercera pata (puesta a tierra) es una medida de seguridad, no puentearla ni eliminarla.

**Desconexión de alimentación eléctrica** • Para desconectar con seguridad la acometida de alimentación eléctrica al equipo, desenchufar todos los cables de alimentación en el panel trasero del equipo, o desenchufar el módulo de alimentación (si fuera independiente), o desenchufar el cable del receptáculo de la pared.

**Protección del cables de alimentación** • Los cables de alimentación eléctrica se deben instalar en lugares donde no sean pisados ni apretados por objetos que se puedan apoyar sobre ellos.

**Reparaciones/mantenimiento** • Solicitar siempre los servicios técnicos de personal calificado. En el interior no hay partes a las que el usuario deba acceder. Para evitar riesgo de electrocución, no intentar personalmente la reparación/mantenimiento de este equipo, ya que al abrir o extraer las tapas puede quedar expuesto a voltajes peligrosos u otros riesgos.

**Ranuras y aberturas** • Si el equipo posee ranuras o orificios en su caja/alojamiento, es para evitar el sobrecalentamiento de componentes internos sensibles. Estas aberturas nunca se deben obstruir con otros objetos.

**Batería de litio** • Existe riesgo de explosión si esta batería se coloca en la posición incorrecta. Cambiar esta batería únicamente con el mismo tipo (o su equivalente) recomendado por el fabricante. Desachar las baterías usadas siguiendo las instrucciones del fabricante.

# System 4.xi Switcher Series

## Getting Started.....



### ◀◀ Step 1 ▶▶

If the System 4.xi is already configured for your model of projector, go to *Step 4*. If it is not set up correctly, it will be necessary to change switch settings on the System 4.xi's Main Controller Board. Continue with *Step 2* below to verify the correct configuration.

### ◀◀ Step 2 ▶▶

Apply power to the System 4.xi. Use the front panel to display the Information Menu (Menu 8). If the configuration is correct, go to *Step 4*. If it is not correct, continue with *Step 3*.

### ◀◀ Step 3 ▶▶

Go to the procedure on page 2-3 of the *System 4.xi User's Manual* to remove the System 4.xi cover. Then go to page 2-4 for instructions on configuring the Main Controller board. The following table and diagram are to be used only as examples of a typical configuration. Please consult either the label inside the System 4.xi top cover or the *System 4.xi Projector Communications Kit* instructions for the correct configuration settings. Continue with *Step 4* below when your configuration is correct.

Config as	Projector	SW1: 1-2-3-4	SW2	SW3	SW4	SW5	SW6	Prj Cable	Comm Adapter
✓	Your Model	off-on-off-on	0	1	0	5	0	J15	26-467-01

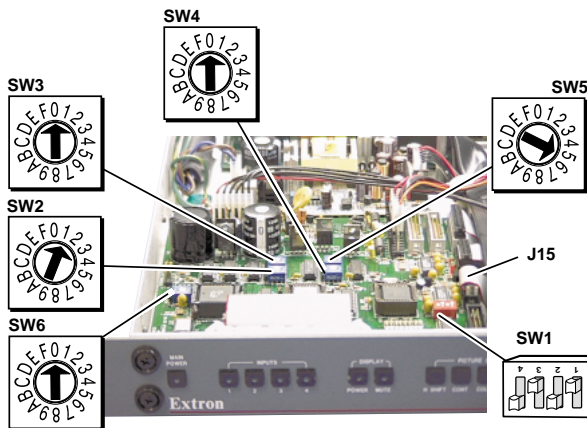

### ◀◀ Step 4 ▶▶

Double-check your work and be sure the System 4.xi cover is back on securely.

### ◀◀ Step 5 ▶▶

Please refer to the appropriate connection diagram for your projector (see your *System 4.xi Projector Communications Kit* instructions). Using the appropriate Communications Adapter included in your Communications Kit, connect the Comm extension cable from the PJ Comm port of the System 4.xi to the Comm Adapter. Secure the Comm Adapter to the appropriate projector port.

### ◀◀ Step 6 ▶▶

Connect the RGBS/HV cable from the System 4.xi output BNC connectors to the projector's matching RGBS/HV input connectors. Verify that all your connections are correct. If in doubt, please refer to the specific installation instructions which were included in your Communications Kit.



CONTENTS

**Chapter One - System 4*x*i Series - Introduction and Features**

Introduction to System 4*x*i ..... 1-1  
 System 4*x*i Features ..... 1-2  
 Specifications ..... 1-4

**Chapter Two - Configuration and Installation**

Rear Panel Connectors and Indicators ..... 2-1  
 Projector/Monitor Applications ..... 2-2  
     Communications Adapters and Cables ..... 2-3  
     User-Supplied Cables ..... 2-3  
 Removing the System 4*x*i Cover ..... 2-3  
 Setting the Main Controller Board for the Projector ..... 2-4  
 Cabling a System 4*x*i in a Rack ..... 2-5  
 Audio Terminal Connections ..... 2-6  
     Audio Wiring Applications ..... 2-6

**Chapter Three - Using the System 4*x*i Front Panel**

Front Panel ..... 3-1  
     Main Power ..... 3-1  
     Inputs ..... 3-1  
     Display Controls ..... 3-1  
     Picture Controls ..... 3-1  
     Breakaway ..... 3-1  
     Audio Mute ..... 3-1  
     Menu Controls ..... 3-1  
     LCD Display ..... 3-1  
 Default LCD Screen ..... 3-2  
 System 4*x*i Model Differences ..... 3-2  
 Menu Controls and Navigation ..... 3-3  
     Terms used in LCD Menus ..... 3-3  
     Example of Using the Menu Controls ..... 3-4  
     Menu System ..... 3-7  
         Menu Select/Exit Menu ..... 3-7  
         Video Mode Configuration ..... 3-7  
         Video Mode Configuration Menu ..... 3-7  
         Audio Level Configuration Menu ..... 3-8  
         Host Baudrate Menu ..... 3-8  
         RGB Delay Menu ..... 3-8  
         Slave Configuration Menu ..... 3-9  
         LD Sync Configuration Menu ..... 3-9  
         Sync Configuration Menu ..... 3-9  
         Information Menu ..... 3-10  
         Slave Switcher Input Selection ..... 3-10  
 Picture Controls (line-doubler/line-quadrupler converter) ..... 3-10  
     Horizontal Shift Control ..... 3-11  
     Contrast Control ..... 3-11  
     Color Control ..... 3-11  
     Tint Control ..... 3-11  
     Detail Control ..... 3-11

System 4 <i>xj</i> Series LCD Menus .....	3-12
Special Functions .....	3-13
System Reset .....	3-13
Toggle Executive Mode .....	3-13

## **Chapter Four - Connecting Multiple Switchers**

Looping the System 4 <i>xj</i> with Other Switchers .....	4-1
Input Channel Addressing .....	4-1
Controlling Master/Slave Switchers .....	4-2
System 4 <i>xj</i> with SW4/6 ARMX Switchers .....	4-3
System 4 <i>xj</i> with One System 8/10 PLUS Switcher .....	4-4
System 4 <i>xj</i> with Multiple System 8/10 PLUS Switchers .....	4-5
System 8/10 Plus Switch Settings .....	4-6
Programming the System 4 <i>xj</i> Looping Configuration .....	4-7
Testing the Master/Slave Communications .....	4-7

## **Chapter Five – Using Windows® Control Software**

Extron System Switcher Control Software .....	5-1
System 4 <i>xj</i> Help (examples) .....	5-2
Executive Mode .....	5-4
Window Pull-Down Menus .....	5-4

## **Appendix A - RS-232 Programming Guide**







Programming the System 4 <i>xj</i> Series Switchers .....	A-1
RS-232 Connections .....	A-1
RS-232 Protocol .....	A-1
Program Instruction Levels .....	A-1
System 4 <i>xj</i> -Initiated Messages .....	A-2
Simple Instruction Set .....	A-3
Related Terms .....	A-3
Simple Instruction List (with examples) .....	A-4
Simple Instruction Examples .....	A-5
Selecting Inputs Using Delimiters .....	A-7
Advanced Instruction Set .....	A-8
Advanced Instruction List .....	A-8
Error Codes (ERC) .....	A-8
Hex, Decimal and Binary Examples for Converting Range Values .....	A-9
Select Input - CMD4 (34h) .....	A-9
Request Status - CMD5 (35h) .....	A-10
Change System Settings - CMD6 (36h) .....	A-11
Set Slave Configuration - CMD8 (38h) .....	A-11
Configure an Input Channel - CMD9 (39h) .....	A-12
Request Input Channel Configuration - CMD10 (3Ah) .....	A-13
Configure System - CMD11 (3Bh) .....	A-14
Request System Configuration - CMD12 (3Ch) .....	A-15

## **Appendix B - General Reference Information**

System 4 <i>xj</i> Related Parts List .....	B-1
Changing the Main Fuse .....	B-2
Les câbles fournis à l'utilisateur .....	B-3
<b>(French)</b> Enlever le couvercle du Système 4 .....	B-3
Câbler un Système 4 sur un rack .....	B-4
<b>(German)</b> Entfernung der System 4 Abdeckung .....	B-5

Verkabelung vom System 4 innerhalb eines Gestells .....	B-6
Upgrading Main Controller Board Software and Battery Replacement .....	B-7

## Legend of Icons

-  Important information – for example, an action or a step that must be done before proceeding.
-  A Warning – possible dangerous voltage present.
-  A Warning – possible damage could occur.
-  A Note, a Hint, or a Tip that may be helpful.
-  Possible Electrostatic Discharge (ESD) damage could result from touching electronic components.
-  Indicates word definitions. Additional information may be referenced in another section, or in another document.

*Extron's System 4<sub>XT</sub> User's Manual  
68-162-01  
First edition – Rev A, 59-07  
Second edition – Rev B, 79-02  
Third edition – Rev C, 99-12  
New format without projectors*





# ***System 4<sub>xi</sub> Switcher Series*** ***User's Manual***

---



# 1 **Chapter One**

## **Introduction and Features**

*System 4<sub>xi</sub> Features*

*Projector/Monitor Applications*

*RGB Decoder, Line Doubler and Line Quadrupler*

*Specifications*

## Introduction to System 4*x*<sub>i</sub>

EXTRON's System 4*x*<sub>i</sub> Series of switchers (henceforth to be referred to as System 4*x*<sub>i</sub>) combines the features of a projector-controlling switcher and a line-doubler or line-quadrupler into a rack-mountable enclosure with an internal power supply. The System 4*x*<sub>i</sub>'s four video inputs can be any combination of the formats listed below and the output will always be RGB. Four stereo audio inputs are also available and can be selected following or separated from the selected video input.

- Composite Video (NTSC/PAL)
- S-video/S-VHS (YC)
- RGBS (NTSC/PAL)
- RGBS (RGB w/separate composite sync)
- RGsB (RGB w/sync on green)
- RGBHV (RGB w/separate H&V sync)

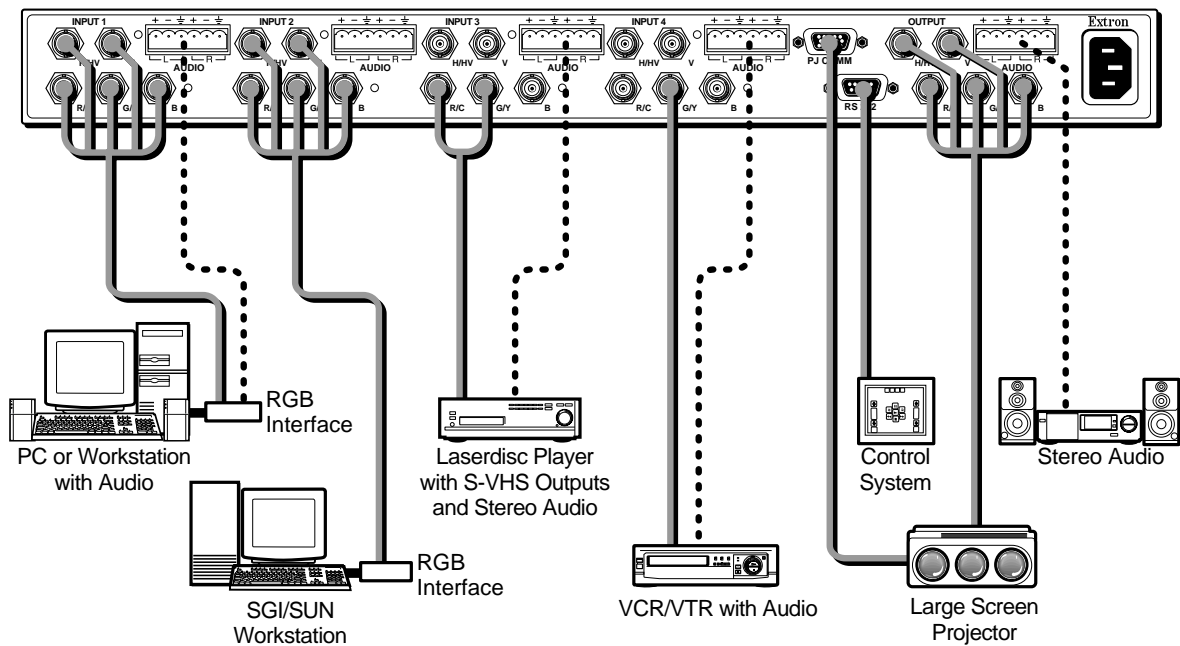

Figure 1-1. Example of a System 4LD*x*<sub>i</sub> Switcher with Input and Output Devices

The System 4*x*<sub>i</sub> has a built-in communications interface that allows it to control projectors made by companies listed below through their switcher control port. Please consult Extron for projector manufacturers not listed here.

- |                      |             |
|----------------------|-------------|
| • Ampro              | • NEC/Runco |
| • Barco              | • Panasonic |
| • Digital Projection | • Sanyo     |
| • Eiki               | • Seleco    |
| • Electrohome        | • Sharp     |
| • Hughes/JVC         | • Sony      |
| • Infocus            | • Toshiba   |
| • Mitsubishi         | • Zenith    |

## **System 4*x*i Features**

### **Universal Video Inputs**

The System 4*x*i has four universal inputs, each capable of accepting all computer RGB signals from 15 kHz to 150 kHz, any composite video standard signals (NTSC or PAL) and S-video (S-VHS) signals. There are no optional modules to purchase for each input signal type.

### **Quad-standard Decoder**

The System 4*x*i is compatible with all standard video formats including NTSC 3.58, NTSC 4.43, PAL and SECAM.

### **Balanced/Unbalanced Audio Inputs**

Every System 4*x*i is capable of switching up to four balanced or unbalanced, left and right stereo audio signals. Audio, input through professional-style captive screw connectors, can be switched to follow any video or RGB input signal, or it may be switched separately for added flexibility (see “Breakaway” below).

### **Audio Follow/Breakaway**

When switching inputs, the System 4*x*i can either select audio and video from the same source (Audio Follow) or select audio from one source and video from another (Breakaway).

### **Three-line Adaptive Comb Filter**

A built-in, three-line adaptive comb filter helps to provide a crisp, stable output from the System 4LD*x*i and 4LQ*x*i.

### **Built-In Line Doubler/Quadrupler (scan doubler/quadrupler)**

The System 4LD*x*i and 4LQ*x*i include a built-in NTSC or PAL compatible line doubler or line quadrupler (4LQ*x*i only) that is capable of line-doubling/quadrupling composite video, S-video or RGB video (Targa or document camera) signals. The signal also passes through a digital noise filter to improve the picture. The line-doubled/quadrupled output results in a sharper image with less noticeable scan lines and “video noise.”

### **300 MHz RGB Video Bandwidth**

The 300 MHz RGB video bandwidth of the System 4*x*i makes it two to three times the performance of any other presentation switcher.

### **LCD Menu-Driven Picture and Programming Controls**

The System 4LD*x*i’s LCD menu makes setup and programming of its features and functions easy and flawless. An alphanumeric display allows for any of the line-doubler/quadrupler controls such as color, hue and contrast to be adjusted to exact specifications for each input.

### **RGB Output**

The System 4*x*i video output will be RGBS or RGBHV if the selected input is configured to be line-doubled or line-quadrupled. If the selected input is not configured to be line-doubled/quadrupled, the output video format will be the same as the input.

### **RS-232 Control**

The System 4*x*i has built-in RS-232 control for external/third party control of any of its features or functions.

### **Triple-Action Switching™ RGB Delay Switching**

Triple-Action Switching makes it possible to have “seamless” picture switching. The System 4*x*i may be programmed to switch the RGB signals to the projector at a specified time after the sync is switched (0 to 5 seconds, in 1/2 second increments). The audience will briefly see a blank screen while the projector “locks on” to the input signal.

### Multiple Switcher Applications

The features of the System 4.xi can be further expanded by connecting the output from another switcher to Input #4. The System 4.xi then functions as the “master”, communicating with the projector and providing it with a signal improved by any of the features described in this section and, if required, can even control the connected projector using their IR (Infra-Red) remote control, RS-232 control, or the built-in LCD menu-driven System 4.xi front panel control.

### Picture Control Memory

All inputs, including those in multiple switcher applications, have a separate memory block for all picture controls of video or RGB and audio signals. When a different video input is selected, the picture controls are updated automatically from the information stored in the Picture Control Memory. RGB inputs in pass-through mode have no stored picture control information.

### Internal Power Supply with Automatic Switching

The System 4.xi is equipped with an internal auto-switching power supply that operates from any input voltage in the 100-240 VAC range, at 50/60Hz.

### Universal Projector Control

The EXTRON System 4.xi and the projector operate as a system that can be controlled several ways:

- *through existing projector controls*
- *through the System 4.xi panel*
- *through a host system using the RS-232 port*
- *using Extron's Windows® Control software*

Using the projector-brand remote control, the System 4.xi can be made to control the following operations:

- *switch inputs*
- *control projector power*
- *mute the audio or video signals*
- *switch input memory blocks (in projector) for convergence*
- *setup saved configurations within the connected projector by input selection*
- *monitor the projector for update changes, feature changes, or input selection changes by the user*

The above operations can also be accomplished by using the System 4.xi front panel controls or through a PC or other control system. The System 4.xi switcher will communicate with the projector and pass it the desired command.

When a projector manufacturer introduces a new model, the System 4.xi can be upgraded to accommodate it by a simple EPROM change (free during the warranty period of two years). When a totally new projector brand and model is introduced, Extron will either add it to the compatibility list for EPROM upgrades, or make it an available “standard” with all future System 4.xi switchers. Call Extron with details of your requirements.

The unique control features of the System 4.xi make using its switcher functions exactly the same as using the projector-brand switcher, but with a 300 MHz bandwidth performance — nearly three times that of most projector- brand switchers.



*Some projector IR remotes do not communicate with the System 4.xi. Also, all projectors have different methods for source and memory recall of source inputs. Please refer to your specific installation instructions for further details.*

## Specifications

### Video input

Number/type .....	4 universal inputs (RGBHV, RGBS, RGsB, RsGsBs, S-video, composite video)
Connectors .....	4 x 5 BNC female
Nominal level(s) .....	Analog — 0.3V to 1.45V p-p
Maximum level(s) .....	Analog — 2V p-p
Impedance .....	75 ohms (deselected inputs)
Horizontal frequency .....	15 kHz to 150 kHz
Vertical frequency .....	30 Hz to 150 Hz
Return loss .....	-30dB @ 5 MHz

### Video throughput

Gain .....	Unity
Bandwidth .....	300 MHz (-3dB)
Crosstalk .....	-80dB @ 3.58 MHz
Switching speed .....	5 mS (max.)

### Video output

Number/type/format .....	System 4LDxi ..... 1 RGBHV, RGBS, RGsB, line-doubled video System 4LQxi ..... 1 RGBHV, RGBS, RGsB, line-quadrupled video
Connectors .....	5 BNC female
Nominal level .....	1V p-p
Impedance .....	75 ohms
Return loss .....	-25dB @ 10 MHz
DC offset .....	±5 mV maximum
Switching type .....	Triple action, 0 S to 5 S, adjustable

### Sync

Input type .....	RGBHV, RGBS, RGsB, RsGsBs
Output type .....	RGBHV, RGBS, RGsB, RsGsBs
Standards .....	NTSC 3.58, NTSC 4.43, PAL, SECAM
Input level .....	0.5V to 5V p-p
Output level .....	0.5V to 5V p-p
Input impedance .....	510 ohms (deselected inputs)
Output impedance .....	75 ohms
Max input voltage .....	5V p-p
Max. propagation delay .....	5 nS
Max. rise/fall time .....	5 nS
Polarity .....	Positive or negative (follows input)

### Audio input

Number/type .....	4 stereo, balanced/unbalanced
Connectors .....	4 5 mm captive screw terminals, 6 conductor
Impedance .....	Unbalanced ..... 10 kohms, AC coupled Balanced ..... 20 kohms, AC coupled
Maximum level .....	+11.2dBu, (balanced or unbalanced) @ stated %THD+N
Input gain adjustment .....	-95.5dB to +31.5dB, adjustable per input

### Audio throughput

Frequency response .....	±0.05dB @ 20 Hz to 20 kHz
THD + Noise .....	0.002% @ 1 kHz at rated maximum output drive
S/N .....	>95dB
Adjacent input crosstalk .....	>85dB @ 20 Hz to 20 kHz
Stereo channel separation .....	>60dB @ 20 Hz to 20 kHz
CMRR .....	>60dB @ 20 Hz to 20 kHz

**Audio output**

- Number/type ..... 1 stereo, balanced/unbalanced
- Connectors ..... 5 mm captive screw terminal, 6 conductor
- Impedance ..... 50 ohms, unbalanced; 100 ohms, balanced
- Gain error ..... ±0.2dB channel to channel
- Drive (HI-Z) ..... > +17.2dBu, balanced or unbalanced at stated %THD+N
- Drive (600 ohm) ..... > +17.2dBu, balanced or unbalanced at stated %THD+N

**Control/Remote — switcher**

- Serial control port ..... RS-232, 9-pin female D connector
- Baud rate and protocol ..... 9600, 8-bit, 1 stop bit, no parity
- Pin configurations ..... 2 = TX, 3 = RX, 5 = GND
- Program control ..... Extron's Windows® control program  
Extron's Simple Instruction Set - SIS  
Extron's Advanced Instruction Set - AIS

**Control — projector**

- Projector control port ..... 1 15-pin HD female connector

**General**

- Power ..... 100VAC to 240VAC, 50/60 Hz, 20 Watts, internal, auto-switchable
- Temperature/humidity ..... Storage -40° to +158°F (-40° to +70°C) / 10% to 90%, non-condensing  
Operating +32° to +122°F (0° to +50°C) / 10% to 90%, non-condensing
- Rack mount ..... Yes, with attached rack ears
- Enclosure type ..... Metal
- Enclosure dimensions ..... 1.75" H x 19" W x 16.2" D  
4.4 cm H x 48.3 cm W x 41.2 cm D
- Shipping weight ..... 17 lbs (7.7 kg)  
DIM weight ..... 21
- Vibration ..... NSTA 1A in carton (National Safe Transit Association)
- Approvals ..... UL, CUL, CE
- MTBF ..... 30,000 hours
- Warranty ..... 2 years parts and labor

**NOTE** Specifications are subject to change without notice.

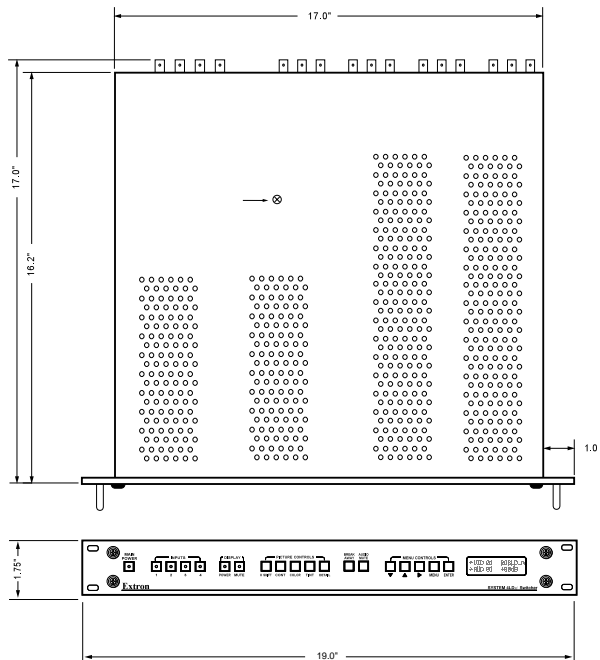

# **System 4<sup>xi</sup> Switcher Series**

## **User's Manual**



# **Chapter Two**

## **Configuration and Installation**

**Rear Panel Connectors and Indicators**

**Projector/Monitor Applications**

**Removing the Cover**

**Setting the Main Controller Board**

**Rack Mounting**

**Audio Connections**

**Connecting to Projectors/Monitors**

## Rear Panel Connectors and Indicators

Use the diagram below to locate the connectors and indicators on the back of the System 4.xi.

All models of the System 4.xi Series have the same rear panel layout.

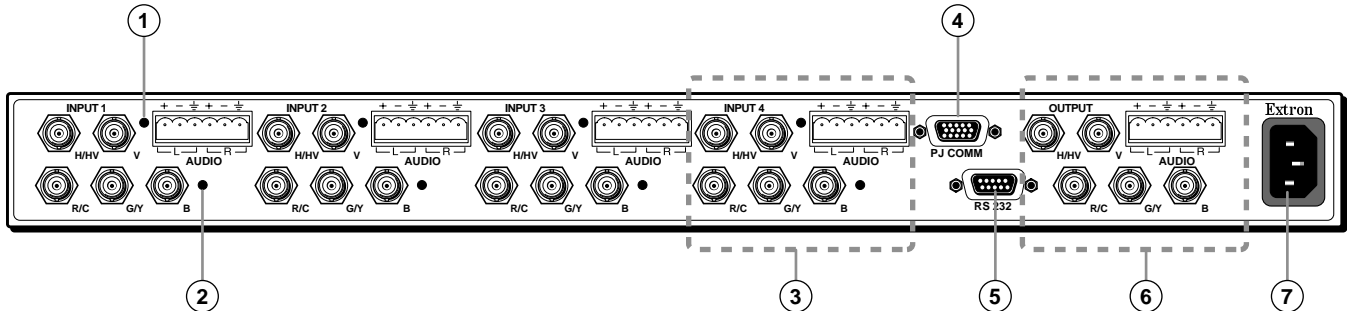

Figure 2-1. System 4.xi Rear Panel Identification

- ① Indicates this Audio Input is selected
- ② Indicates this Video Input is selected
- ③ Audio (left & right) and Video Input #4 (also used for Slave input in a multiswitcher system)
  - Video Input formats: Composite Video — use G connector
  - S-video — use C & Y connectors
  - RGB — use R, G & B connectors
  - RGBS — use R, G, B & HV connectors
  - RGBHV — use R, G, B, H & V connectors
- ④ Projector Communications
- ⑤ RS-232 port for control by host system
- ⑥ Audio and Video Output to projector/monitor
- ⑦ AC Power input to Autoswitching power supply



## Projector/Monitor Applications

The System 4*x*i can be configured for most projectors. Some of the projector manufacturers that Extron supports are:

- Ampro
- Barco
- Digital Projection
- Eiki
- Electrohome
- Epson
- Digital Projection
- Hughes/JVC
- Infocus
- Mitsubishi
- NEC
- Panasonic
- Seleco
- Sharp
- Sony
- Toshiba
- Zenith

If your projector manufacturer is not on the above list, please consult your Extron representative.



Because this manual is for the System 4*x*i Series switchers, the name “System 4*x*i” will be used except when referring to a specific model.

The following diagram is a typical example of System 4*x*i-to-projector cabling. However, before connecting the cables, verify that the System 4*x*i is already configured for your projector/monitor.

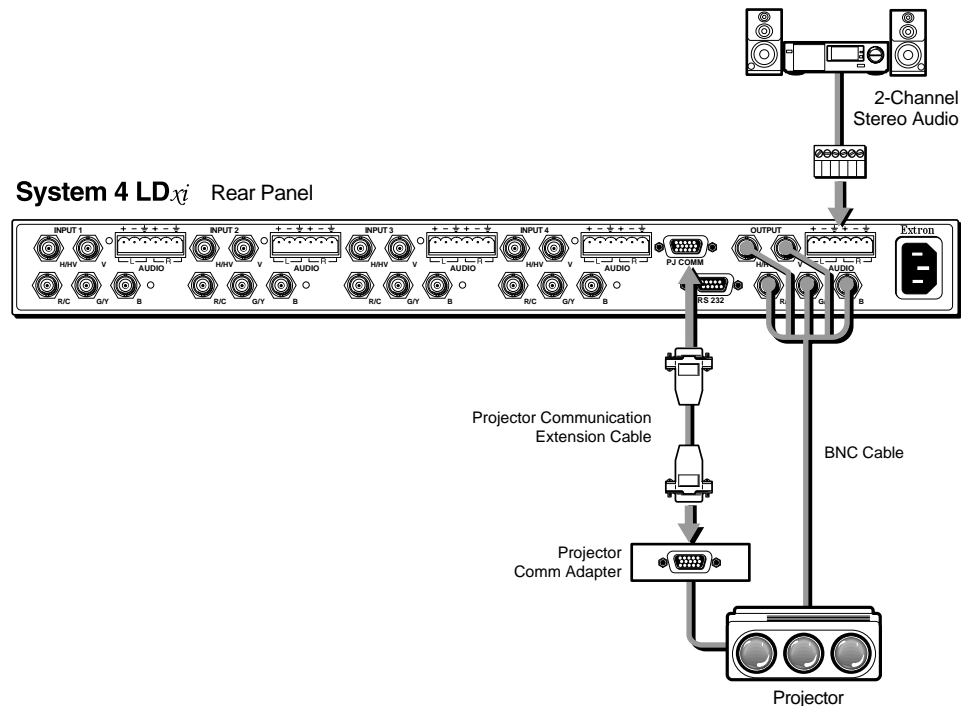

**Figure 2-2. System 4*x*i Outputs. A factory label identifies the configuration.**

Configuring the System 4*x*i for your application requires the following major steps using the *System 4*x*i Projector Communications Kit* instructions for your specific projector or monitor:

1. The System 4*x*<sub>i</sub> must be configured internally for the projector/monitor to be used. This is done at the factory when the unit is ordered, and a label is placed on the rear panel to identify the configuration. However, there may be times when the configuration must be changed for a different application.
2. Place, or mount, each piece of equipment in the location where it will be used.
3. Connect the cables and adapter between the System 4*x*<sub>i</sub> and the projector.
4. Connect other equipment, such as audio or various controlling devices.
5. Set up the projector, using the manual(s) provided by the manufacturer.

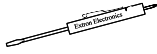

There are procedures in this chapter for installation of specific projectors to the System 4*x*<sub>i</sub>. Use the appropriate procedure for your application.

**Communications Adapters and Cables**

Because there are projector differences, Extron makes communication adapters for the projector types listed on the previous page.

Each System 4*x*<sub>i</sub> package includes the following:

- 1 System 4*x*<sub>i</sub> (factory-configured for the customer)
- 1 Comm Adapter (specified by the customer)
- 1 CC 50' Projector Communications Extension cable
- 5 Audio connectors with captive screws (audio cables not included)
- 1 AC Power Cord
- 1 Tweaker (combination screwdriver)

**User-Supplied Cables**

For custom installations, you may choose to make your own Projector Communication cables (CC-xx'). Refer to the cable wiring diagram below for pin connections. Cables may be up to 200' in length.

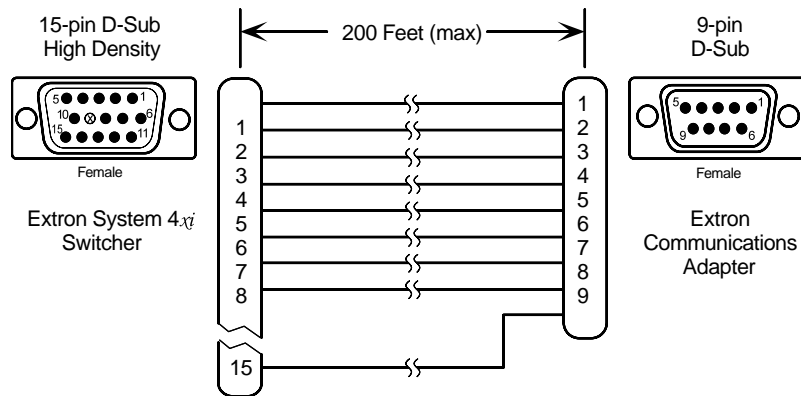

**Figure 2-3. Communications Cable Wiring Diagram**

**Removing the System 4*x*<sub>i</sub> Cover**

If the System 4*x*<sub>i</sub> must be reconfigured for a different display device, it is necessary to access the Main Controller board. Also, if the main power fuse needs to be changed, you will need to access the inside of the unit. To do either of these two things, you must first remove the top cover of the System 4*x*<sub>i</sub>, as follows:

1. Unplug the AC power cord.
2. If rack-mounted, remove the System 4*x*<sub>i</sub> from the mounting rack.
3. Label the input and output cables and remove them.

4. Place the System 4*x*i on a clean work space and remove eight (8) screws shown in Figure 2-4.
5. Lift the cover straight up.
6. Go to the procedure for which you have opened the cover (projector configuration or changing the fuse).
7. Reverse this procedure when finished working inside the System 4*x*i.



Do NOT touch any switches or electronic components, other than those specified. This could seriously affect the operation of the system.

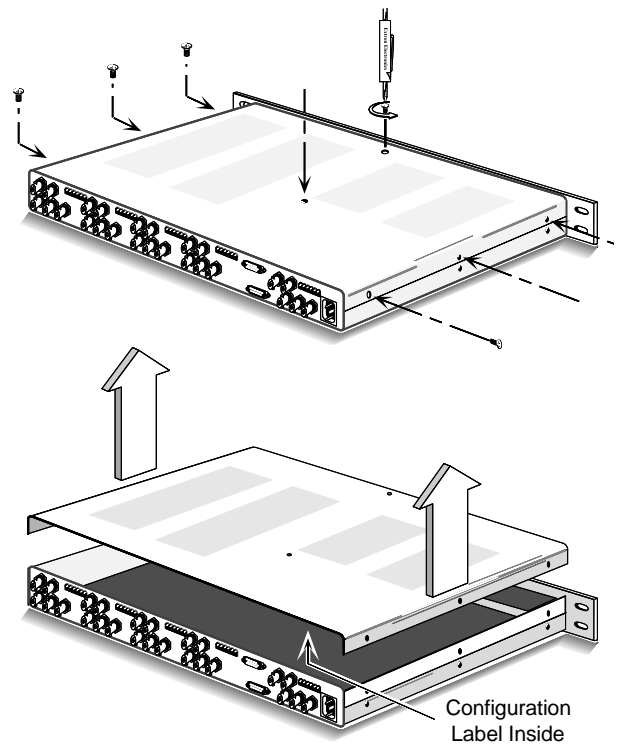

**(French)** Enlever le couvercle du Système 4*x*i - page B-3

**(German)** Entfernung der System 4*x*i Abdeckung - seite B-5

Figure 2-4. Removing the System 4*x*i Cover

### Setting the Main Controller Board for the Projector

Before each System 4*x*i ships, it is set for the application specified by the customer. The projector name is on a label on the rear panel (see Figure 2-1). However, if there is a need to change these settings (e.g. using a different projector/monitor), switch settings must be changed on the Main Controller board.

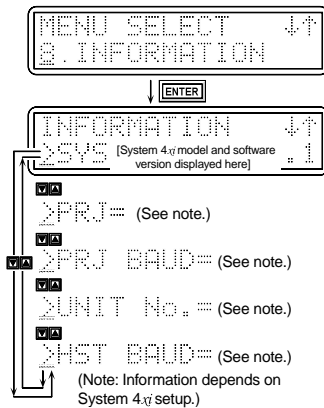

1. If you are not sure if the System 4*x*i is set for your projector/monitor, use the Front Panel to select the Information Menu (#8), and then display the System 4*x*i settings (see page 3-10). A general example is shown to the left. Refer to Figure 2-5 below as an example only to locate the switches and projector cable. Configuration information is located on a label inside the System 4*x*i top cover. If the projector cable is on the wrong connector, or if DIP switches (1-4) are incorrect, this error will not be seen in Menu 8.

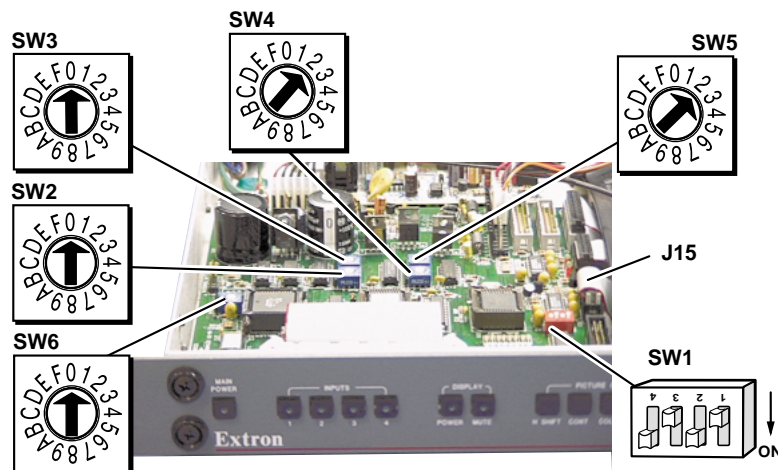

Figure 2-5. Example of Setup Switches on the Main Controller Board

2. If your unit is not set up correctly, remove the System 4.xi cover (page 2-3) and locate the switches and projector connectors. Note the orientation of the SW1 switches in the picture. “On” is marked on the DIP switch block.
3. Set the switches as indicated by the label or the instructions included with the projector communications kit and verify that the Projector cable is on the correct connector (J9/J15).



*Extron continues to support new projectors. If you have questions about using the System 4.xi with a device for which you cannot find configuration settings, please consult with your Extron representative.*

4. Refer to the appropriate cabling procedure included with the projector communications kit to continue the installation.

### **Cabling a System 4.xi in a Rack**

When routing cables from one unit to another in a rack, do NOT allow the cables to be supported by the System 4.xi (see Figure 2-7). Use “Tie Wraps”, “Rip-Ties” or other devices, to secure the cables at some point in the rack that is above the rear panel connectors. Loosely hanging cables may be stepped upon, resulting in damage to cables and equipment, as well as injury to personnel.

The example shown in Figure 2-6 has the cables tied to the rack above the connections to the equipment. This allows an unobstructed view of the rear panel connectors, and prevents the cable weight from pulling down on the equipment.

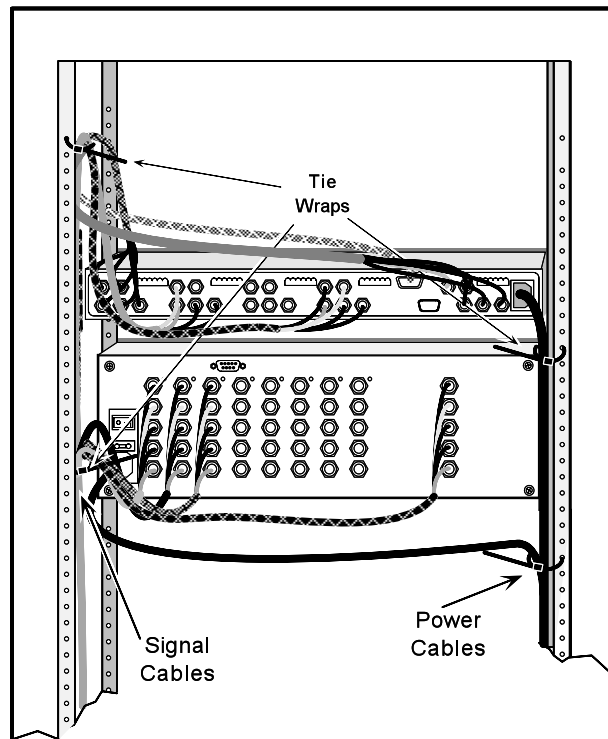

**Figure 2-6. Route the Signal Cables on the Left and Power Cables on the Right**

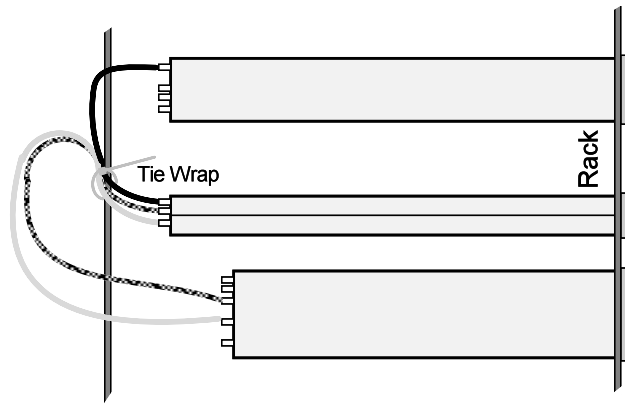

Figure 2-7. Tie Cables to Prevent Pulling Down on the Units

- ▲ ————— Be sure that no weight is added to the System 4*xi* in excess of 10 lbs (3.73 kg).
- ▲ ————— The holes in the top and bottom of the System 4*xi* enclosure are for cooling. Do NOT cover these holes. This could cause overheating of vital components.
- ▲ ————— Maximum ambient operating temperature must not exceed 104° F (40° C).
- ▲ ————— The mounting rack, and all equipment mounted in it, must be grounded according to national and local electrical codes.
- ✍ ————— Keep power and signal cables separate (power cables on the right and signal cables on the left.)

**(French)**

Câbler un Système 4*xi* sur un rack - page B-4

**(German)**

Verkabelung vom System 4*xi* innerhalb eines Gestells - seite B-6

**Audio Terminal Connections**

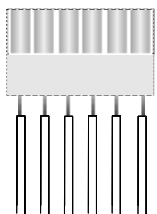
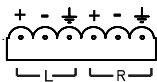

The rear of the System 4*xi* has five audio connectors (four input and one output). Each connector has six pins for a left and a right audio channel. One example is shown here in Figure 2-8.

The 6-terminal, captive screw connectors are supplied with the switcher for wiring the audio cables. The connectors are then plugged into the appropriate position in the audio terminal strip on the rear panel. The audio area of the back panel is labeled “R” (right) and “L” (left) for each channel.

When wiring the connectors and plugging them into the System 4*xi* switcher, the screw heads (see figure right) must face **down**.

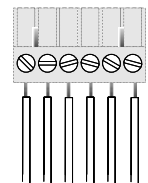
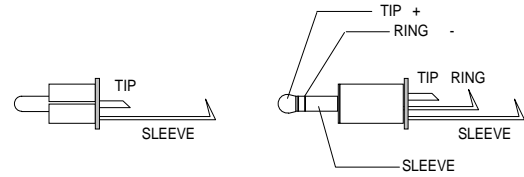

Figure 2-8. Captive Screw Audio Connectors (above and right)

**Audio Wiring Applications**

Three methods of wiring the connectors for input and output are listed here, and illustrated in Figure 2-10. (The connector screws do not show in Figure 2-10 because they are on the other side.)

- Unbalanced High Impedance (High Z) Stereo Tip, Ring, Ground (Left & Right)
- Balanced High Impedance (High Z) Stereo Tip, Ring (Left & Right)
- Balanced 600Ω input Impedance Stereo Tip, Ring (Left & Right)



**Figure 2-9. The Audio Cable Equivalent Connections**

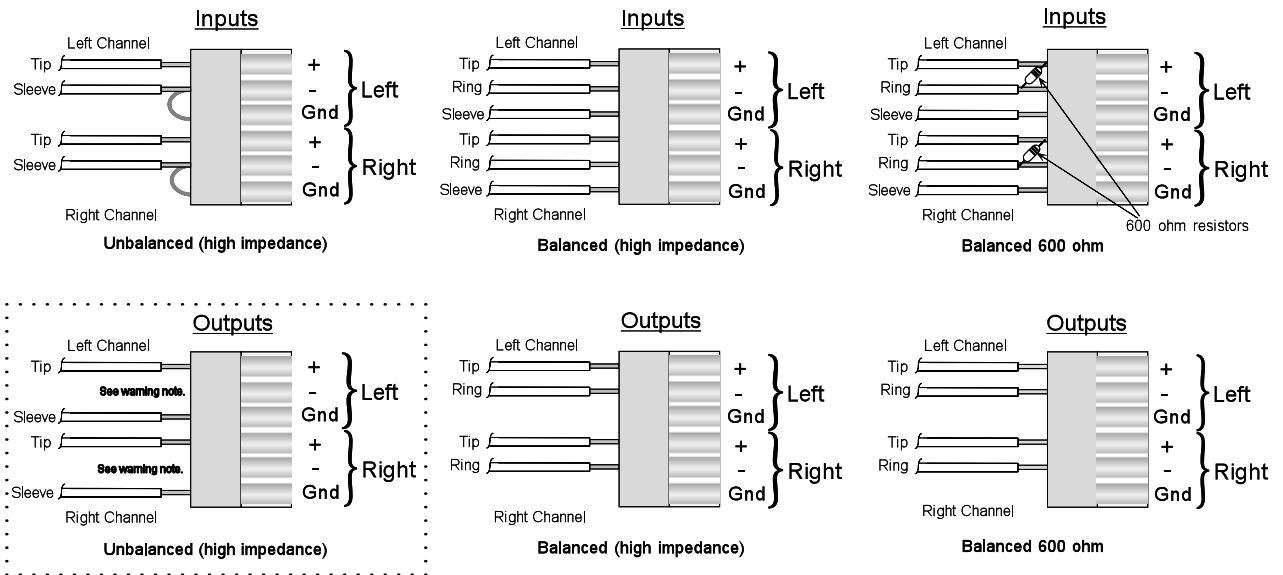

**Figure 2-10. Three ways to Wire the Input and Output Audio Connectors**

△ ————— If using unbalanced audio output, use lower-left connector as an example, and connect the sleeve to Gnd. Connecting it to the negative (-) terminal will damage audio output circuits.

————— Use captive-screw audio connectors, Extron part number 10-163-01

# **System 4<sup>xi</sup> Switcher Series**

## **User's Manual**

---



# Chapter Three

## **Using the System 4<sup>xi</sup> Front Panel**

*Front Panel Buttons and Indicators*

*Picture Controls for Line Doubler and Line Quadrupler*

*Examples for Using Some of the Menus*

*Using Menus to Make Adjustments*

*Using Menus to Configure the System*

**Front Panel (4LD<sub>xi</sub> model shown)** Controls are described beginning from the left side.

**Figure 3-1. System 4LD<sub>xi</sub> Front Panel (other System 4<sub>xi</sub> Series front panels are very similar)**

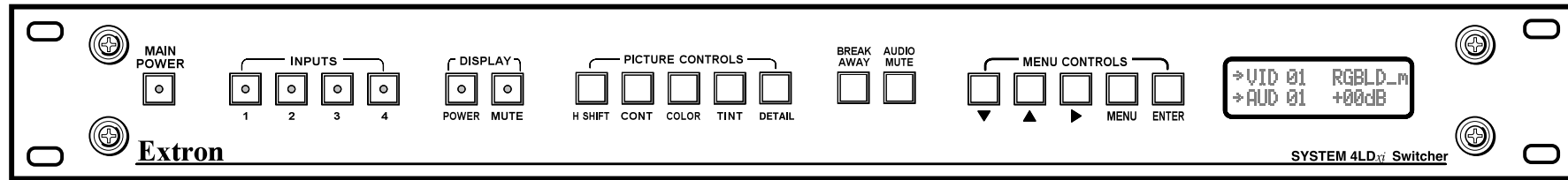

### MAIN POWER

This button turns the System 4<sub>xi</sub> power On or Off. The light indicates when power is On.

### INPUTS

Inputs (1 thru 4) buttons are used to select which of the four possible inputs will go to the output (projector or monitor).

### DISPLAY CONTROLS

**POWER** - allows the connected display power to be turned On or Off from the System 4<sub>xi</sub>. The LED lights when power is On.

**MUTE** - commands the attached display picture to be muted (blanked). The LED is lighted when the picture is being muted.

### PICTURE CONTROLS (depends upon the System 4<sub>xi</sub> model)

These buttons only affect line-doubled/quadrupled signals, as well as decoded composite and S-video signals. (Functions marked with ‡ do not affect line-doubled/quadrupled RGB.) When pressed, each button brings up an LCD display which is used with Menu Controls to make adjustments.

**H SHIFT** - brings up an LCD display for Horizontal Shift adjustment. This allows the picture to be adjusted left or right.

**CONT** - (‡) brings up an LCD display for adjusting the picture Contrast.

**COLOR** - (‡) brings up an LCD display for adjusting the Color level.

**TINT** - (‡) brings up an LCD display for adjusting the Tint or Hue.

**DETAIL** - (‡) (only on 4LD<sub>xi</sub>/ex and 4LQ<sub>xi</sub>/ex models) brings up an LCD display to adjust up to 4 levels of picture Detail (sharpness).

 - After making an adjustment, press the same Picture Control button to save the setting and exit from the display.

### BREAKAWAY

The Breakaway button allows the audio and video signals to be separated from (Breakaway) or combined with (Follow) each other to the output. There are three choices: Video & Audio, Video only or Audio only. The current condition is displayed in the LCD panel by arrows on the left side.



 - In Executive mode (explained later) audio always follows video.

### AUDIO MUTE

This button allows the audio to be muted (temporarily turned off). When Audio is muted, the LCD panel alternately displays the word "Muting" and then the current dB level.

### MENU CONTROLS

The Menu Control buttons are used with the LCD screen to display and make changes to system settings.

  - The Up and Down buttons are used to change a selection or a value in the LCD display.

 - The Tab button is used to step from one selection point to the next on the LCD display.

(Button combinations are used for special functions – explained later.)

 - The Menu button is used to display a Select menu, which is used to select other control menus.

 - The Enter button is used to enter a menu sequence, save a setting and/or complete an operation.

### LCD DISPLAY

The LCD screen displays System 4<sub>xi</sub> status and is used interactively with front panel buttons when making changes to settings.



## Default LCD Screen

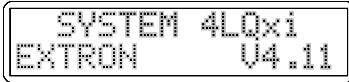

When the System 4*x*i is powered up, a Title screen appears briefly, followed by the Default display. Examples are shown to the left. This manual covers different System 4*x*i models; an appropriate screen will appear displaying your model and software version.

The Default screen (shown to the right) will continue to display whenever the panel is not being used. It displays the current status of the input(s), with the following information:



### Video Configuration

The top line displays which video input channel is selected and its Video Mode. The example shows that Video input #1 is selected, with RGB and Sync. Other modes are explained later. The Arrow to the left (→ VID) indicates that video is being switched (not Breakaway).

### Audio Configuration

The second line provides the current audio configuration. The example shows that Audio input #1 is selected and the arrow (→ AUD) indicates that audio is being switched (Audio Follow). The gain/attenuation is set at 0 dB for that input.

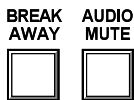

### Breakaway

As mentioned earlier, the Breakaway button allows Audio and Video to be separated. The three breakaway steps are: Video and Audio (both), Video only, and Audio only. The Default Display indicates this condition by turning off the arrow for the signal that is not being sent to the output.

### Audio Mute

As stated on the previous page, the Audio Mute button temporarily turns the audio Off. The Default Display indicates this condition by alternately displaying the word "Muting" and the dB level.

When the default menu is being displayed, pressing a Front Panel button will then change the screen to display appropriate information. These LCD screens, or menus, are explained later.

## System 4*x*i Model Differences

This chapter covers all both System 4*x*i models. Each model has different features, and a different Front Panel. Because the System 4LD*x*i and 4LQ*x*i have the most features, page 3-1 shows a 4LD*x*i front panel; all System 4*x*i panels are shown below. The most obvious differences are in the number of Picture Control buttons. Other differences will appear when using the LCD menus.

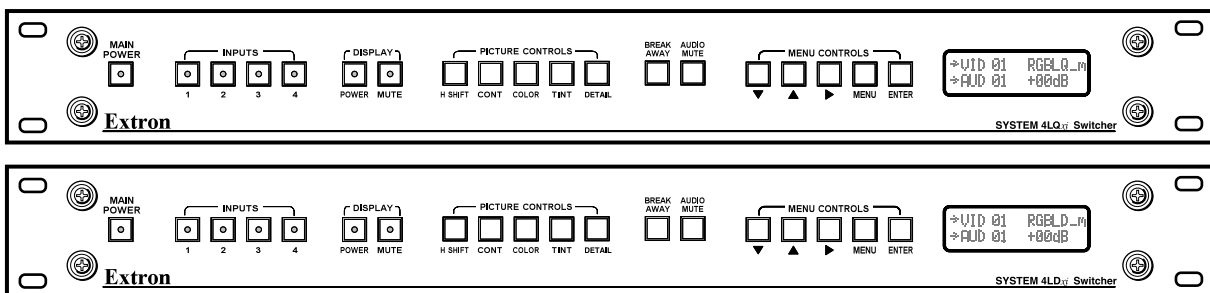

Figure 3-2. System 4*x*i Front Panel Differences

## Menu Controls and Navigation

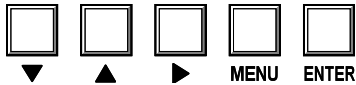







Figure 3-7 on page 3-12 shows a flowchart of all the menus. Use it as a road map or guide to get to a specific one.

There are two groups of menus. There is a menu for each of the Picture Control buttons on the front panel. These are explained on page 3-12 . The larger portion of the flow diagram is a network of menus for setting up (or displaying) the System 4*x*i input and output configuration, and are selected from the five Menu Control buttons on the Front Panel (shown above). The text and diagrams in this section include symbols that represent these panel buttons. They are: , , ,  and .







The Menu Control buttons are used with the LCD screen for viewing status, changing settings, and making adjustments to the System 4*x*i configuration. Each menu is described later. The Menu button (  ) is the starting point.

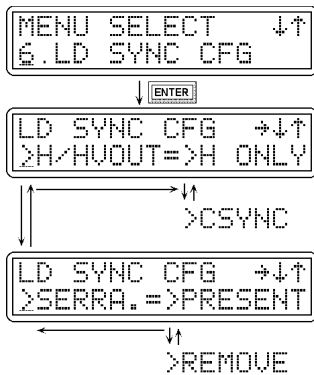

Press  at any time to leave a menu and return to the Select/Exit menu.

The LCD menus include "Help" symbols to indicate how to use them. An example of these symbols can be seen in the menus to the left. Their descriptions are as follows:



- The arrows in the upper-right corner (→ ↓ ↑) of the display indicate which of the direction buttons, , , , may be used with this menu. These buttons allow the user to step forward, backward, or loop through menu choices.
- The character ">" marks a selection point where the user may choose between two or more options. For menus that have more than one selection point, use the  button to step from one selection point to the next (and then loop back to the first).
- The character "\_" is the cursor position. Use  or  to change the display to the right of the cursor and make a different selection. When a function blinks, that indicates a tentative decision. That is, you have displayed something, but have not yet made the selection. Press  to select and save it. If a function does not blink, it is already selected, or active.



To exit a Control Menu at any time, without saving changes, press any of the four input buttons to return to the Default menu. (If you don't want to change input selections, press the button for the input that is already selected.)

## Terms used in LCD Menus

- AUD** = Audio
- CHL** = Input channel (used in Menu #9). It includes both Audio and Video.
- CFG** = Configuration, as in setup
- H** = Horizontal, as in horizontal sync
- H/V** = Horizontal and Vertical, as in composite sync (H and V)
- LD** = Line-doubled output (LQ = Line-quadrupled output)
- RGB** = Red, Green and Blue colors or video signals
- RGsB** = Red, Green and Blue, and the sync included with the Green signal
- RGBS** = Red, Green and Blue, and the Sync (H and V) on a 4th line
- Slave** = Another switcher whose output serves as an input to a System 4*x*i.
- \_m** = Motion - use this for video with action.
- \_s** = Still - use this for text or still pictures (slide presentations)
- VID** = Video
- YC** = S-Video, for the chrominance (C) and the luminance (Y)
- V** = Vertical, as in vertical sync



The following pages have examples for using some of the menus, as well as details on the function of each menu. Page 3-12 (Figure 3-7) has a flowchart of the LCD menus. You may use it as a road map to go from one menu to another.

### Example of Using the Menu Controls

Suppose we have a System 4LD<sub>xi</sub> and want to set up Input #2 for line-doubled, motion video in a VGA format with separate horizontal and vertical sync, negative polarity and serration pulses. Follow the numbered steps below as you refer to the corresponding numbers in the flowchart in Figure 3-3 for Menu #1, in Figure 3-4 for Menu #6, and in Figure 3-5 for Menu #7.

Menu #1 is used to configure the type of output you want from each input.

- 1 Press **MENU**  
Enter Menu Select Options (Menu #0).
- 2 Press **▼** or **▲** to get Menu #1 (Vid Mode CFG).
- 3 Press **ENTER** to select this menu.
- 4 With the cursor (**\_**) at the left position (**>**), the display shows VID01 selected. Press **▼** or **▲** to display Input #2 (VID02).
- 5 Press **▶** to step to the next selection point (**>**).
- 6 Press **▼** or **▲** to display RGBLD<sub>m</sub>. (Output will be line-doubled, motion video for Input #2.)
- 7 Press **ENTER** to save this setting for Input #2. Press **MENU** to exit this menu and go to Menu #0.
- 8 From Menu #0 you may start your next setup procedure, or press **ENTER** to return to the Default Menu.



A detailed explanation of each menu follows, beginning with Menu #0 on page 3-7.

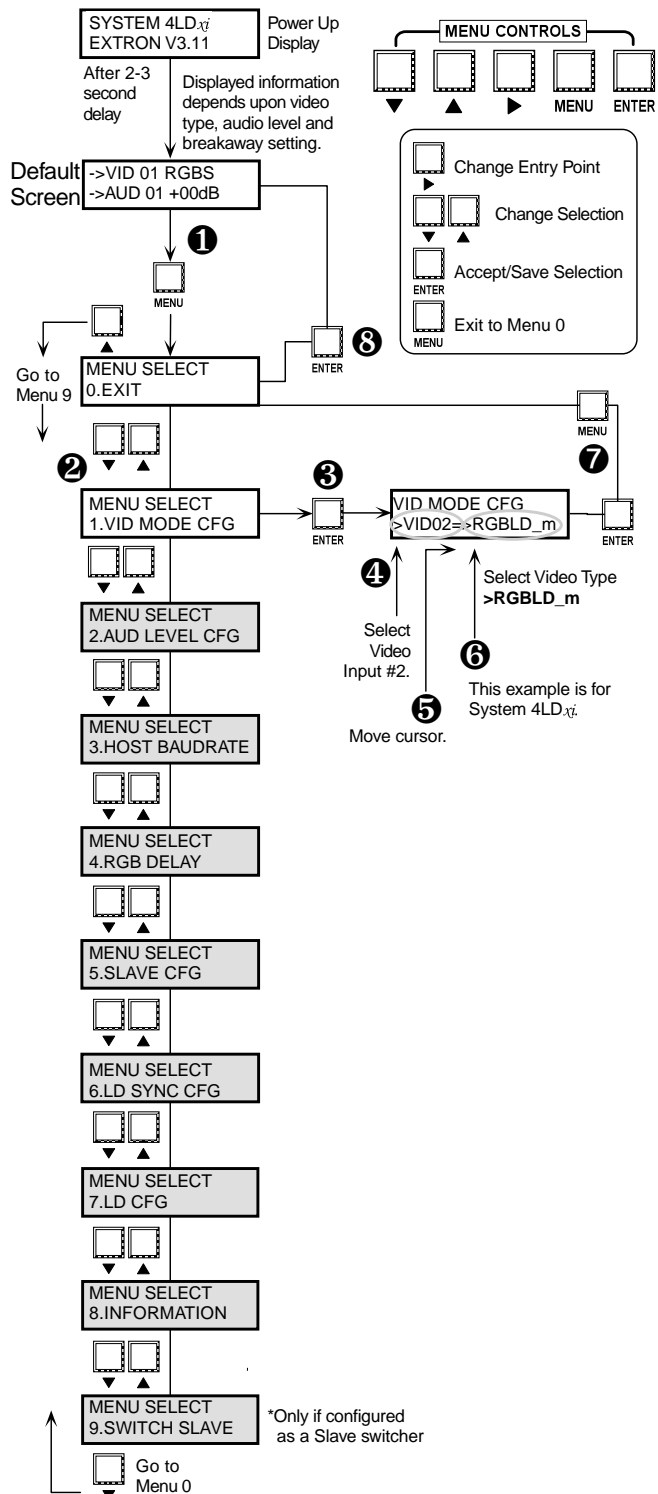

Figure 3-3. Example: Configuring System 4 Inputs

Menu #6 is used to set up composite or separate horizontal and vertical sync for line-doubled/quadrupled images. Follow the numbers in the diagram and continue.

- 1 Press **[MENU]** to get the Menu Select Options (Menu #0).
- 2 Press **[↓]** or **[↑]** to get Menu #6 (LD Sync CFG).
- 3 Press **[ENTER]** to select this menu. There are four functions in this menu as displayed from the left selection point. They are listed in the diagram. Use **[↓]** to move between the two selection points, and then use **[↓]** or **[↑]** to show the choices, and leave your choice displayed before going to the next function.
- 4 From the left selection point, press **[↓]** or **[↑]** to choose one of the four functions.
- 5 Press **[↓]** to step to the second selection point and press **[↓]** or **[↑]** to change the selection for that function. If the display already shows what you want, leave it and go on. The choices made for this example are circled.
- 4 Press **[↓]** to step back to the left selection point. Repeat steps 4 and 5 until you have made all of your changes to this menu.
- 6 Press **[ENTER]** to save these settings and press **[MENU]** to go to Menu #0. From there you may step to another menu and start your next setup procedure, or exit.
- 7 Press **[ENTER]** to exit Menu #0 and go to the Default Menu.

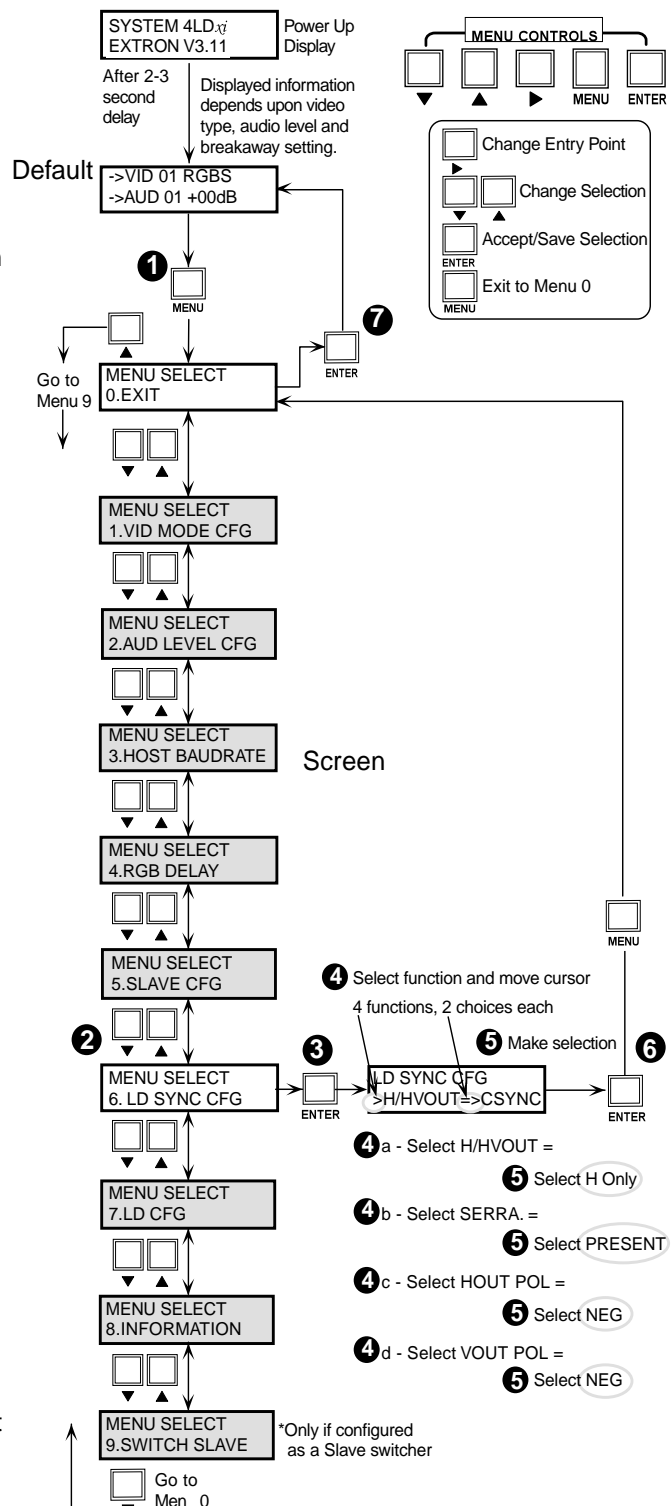

Figure 3-4. Example: Configuring System 4 Output Sync for Line Doubled/Quadrupled Sources



A detailed explanation of each menu follows, beginning with Menu #0.

Menu #7 is used to set up Demo and VGA modes.

- ➊ Press **[MENU]** to get the Menu Select LCD (Menu #0).
- ➋ From Menu #0, press **[▼]** or **[▲]** to go to Menu #7.
- ➌ Press **[ENTER]** to select this menu. There are two functions in this menu as displayed from the left selection point. They are listed in the diagram. Use **[▶]** to move between the two selection points, and then use **[▼]** or **[▲]** to show the choices, and leave your choice displayed before going to the next function.

- ➍ From the left selection point, press **[▼]** or **[▲]** to choose one of the two functions.

- ➎ Press **[▶]** to step to the second selection point and press **[▼]** or **[▲]** to change the selection. If the display already shows what you want, leave it and go on. Repeat ➍ and ➎ to make other changes to this menu. The choices for this example are circled.

- ➏ Press **[ENTER]** to save these settings and press **[MENU]** to go to Menu #0. From here you may step to another menu and start your next setup procedure, or exit.

- ➐ Press **[ENTER]** to exit Menu #0 and go to the Default Menu.

 *VGA mode is only available on System 4LD*x*i.*

 *A detailed explanation of each menu follows, beginning with Menu #0 on page 3-7.*

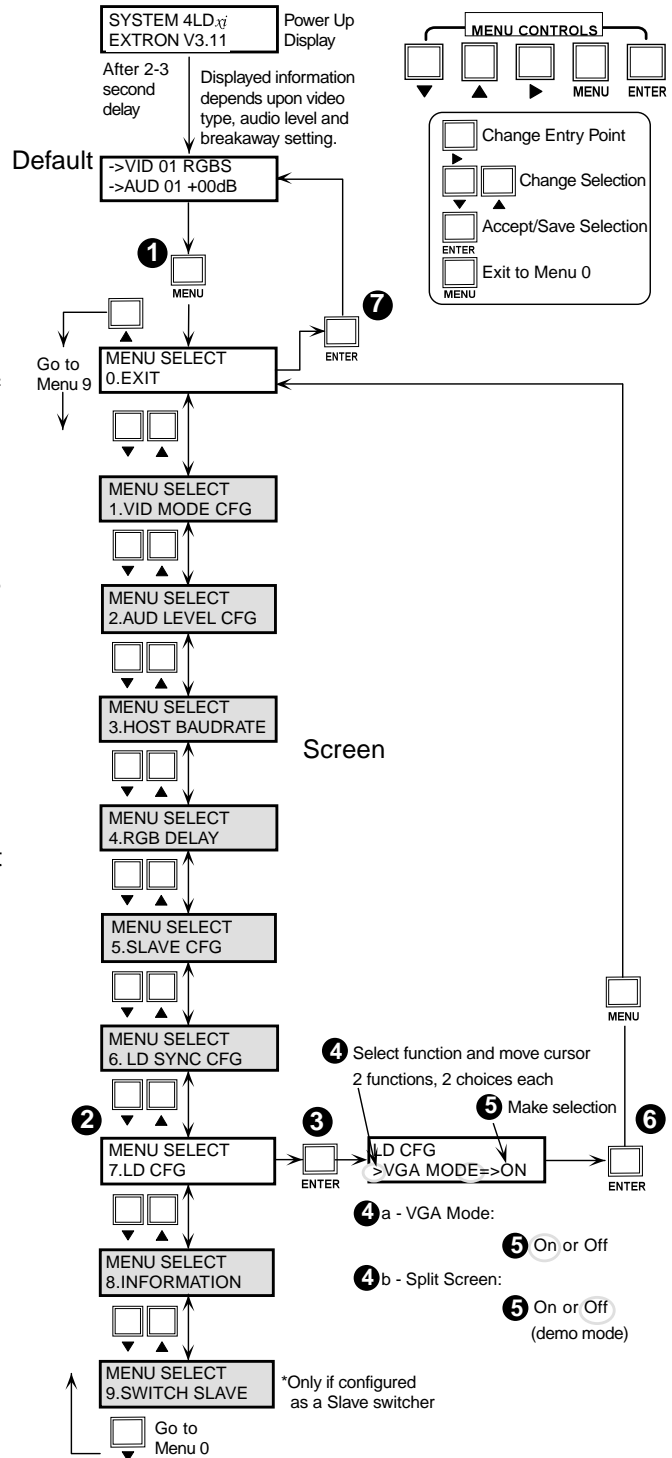

**Figure 3-5. Example: Configuring the System 4*x*i Line-Doubled Output to be exactly 640 x 480, standard VGA mode**

## 0. Menu Select/Exit Menu

The Menu button ( **MENU** ) brings up the Menu Select/Exit screen. This is the starting point to get into any of the Control Menus. Some menus in this chapter have more than one example. This is because of the different System 4*x*i models. Be sure to use the example for the System 4*x*i model you are using.

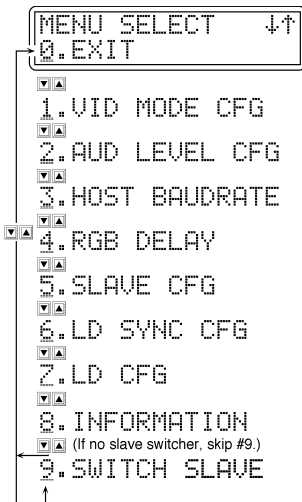

The example here is for the System 4LD*x*i model (4LQ*x*i is very similar except for references to line quadrupler).

Press **▼** or **▲** to select from the following menus.

- 0. Select/Exit Menu - Press **ENTER** to return to the default screen.
- 1. VID MODE CFG - Configure a video input channel.
- 2. AUD LEVEL CFG - Configure an audio input channel.
- 3. HOST BAUDRATE - Set the RS-232 baudrate for the host system.
- 4. RGB DELAY - Set the time delay for switching the RGB signals (after Sync).
- 5. SLAVE CFG - Set the System 4*x*i for use with a slave switcher.
- 6. Change Line-doubler Sync output configuration.
- 7. Change Line-doubler display to VGA mode or Split Screen (demo).
- 8. Display Information (of internal switch settings).
- 9. Switch Slave - (only appears if the System 4*x*i has slave configuration)  
Select slave channels from System 4*x*i front panel. See Chapter 4.

Press **ENTER** to select the menu being displayed.

Each of the menu choices listed in Menu #0 is explained later in this chapter.

## 1. Video Mode Configuration

The next two pages show three different versions of Menu #1 to cover the different models in the System 4*x*i Series of products. Use the one that is appropriate for your model.

Use the Video Mode Configuration Menu (Menu #1) to match the type of video with the signal coming into each input and choose how it will output. For example, if Input #3 has S-video coming in and you want it line-doubled when it goes to your projector, select VID03 and select YCLD (\_m or \_s for *x*i models)

The System 4LD*x*i and 4LQ*x*i models can have line-doubled (or quadrupled) output with the *motion* or *still* attribute. If the application includes action video (movies, etc.) use the *motion* attribute; if it is a slide presentation (still pictures and text), use the *still* attribute. Each setup done in Menu #1 is stored with its respective channel.

### 1a. Video Mode Configuration Menu (System 4LD*x*i\*/4LQ*x*i format options)

Use **MENU** **▼** **▲** to get to this menu, and then press **ENTER** to select it.

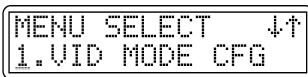

The two cursor points in the Video Configuration menu are indicated by the character ">".



With the cursor in the left position, use **▼** or **▲** to select a video input channel. Only the available channel numbers (System 4*x*i plus slave inputs) will display.

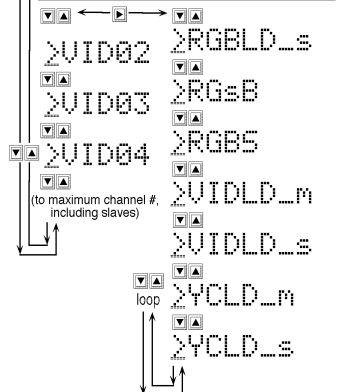

Use **▶** to step between the two positions. Use **▼** or **▲** to select the video format to assign to this channel number.

- RGBLD\_m = Input is RGB\*\* and Sync and output will be line-doubled, motion.
- RGBLD\_s = Input is RGB\*\* and Sync and output will be line-doubled, still.
- RGsB = Input is RGB with Sync on Green and will pass to output.
- RGSB = Input is RGB and Sync (composite or H&V) and will pass to output.
- VIDLD\_m = Input is Composite Video and output will be line-doubled, motion.
- VIDLD\_s = Input is Composite Video and output will be line-doubled, still.
- YCLD\_m = Input is S-video/S-VHS and output will be line-doubled, motion.
- YCLD\_s = Input is S-video/S-VHS and output will be line-doubled, still.

When a change is selected, but not yet saved, the selection blinks.

Press **ENTER** to save the selection to memory.  
Repeat the above for other input channel numbers.

Press **MENU**, **ENTER** to go back to the Default Menu.



*If the change is made for the input that is currently selected, the projector won't display the change until the next time the input number is selected.*

\*4LD*x* shown here

\*\*Only NTSC (15.75 kHz) RGB signals can be line-doubled or line-quadrupled

## 2. Audio Level Configuration Menu

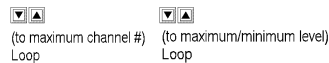
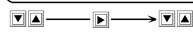
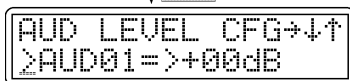

Use **MENU**, **▼**, **▲** to get to this menu, and then press **ENTER** to select it.

There are two cursor points in the Audio Configuration menu, indicated by the character ">". Use **▼** to step between the two positions.

With the cursor in the left position, use **▼** or **▲** to select a audio input channel. Only available channel numbers will display.

With the cursor at the right position, use **▼** or **▲** to set the audio gain/attenuation level for the selected input channel. The range is from -31dB to +31dB.

When a change is selected, but not yet saved, the dB value blinks.

When an audio input is selected, it is connected to the output (except when muted). This menu allows each audio input to be set to match the others.

Press **ENTER** to save the selection to memory.

Press **MENU** or any input button at any time to exit.

## 3. Host Baudrate Menu

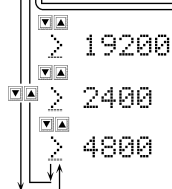
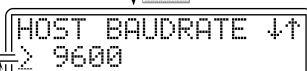

Use **MENU**, **▼**, **▲** to get to this menu, and then press **ENTER** to select it.

Only the baudrate can be changed; the protocol remains the same.

Use **▼** or **▲** to select the baudrate for the host system on the RS-232 port. The choices are listed in the illustration.

- The default baudrate is 9600.
- The fixed protocol is 8-bits, 1 stop bit, no parity.

When a change is selected, but not yet saved, the value blinks.

Press **ENTER** to save the selection to memory.

Press **MENU** to go to Menu #0 and then **ENTER** to go back to the Default Menu.

## 4. RGB Delay Menu

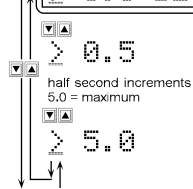

Press **MENU**, **▼**, **▲** to get to this menu, and then press **ENTER** to select it.

Use this menu to set the time delay for switching the RGB on after the sync has switched. Use **▼** or **▲** to select the number of seconds (0 to 5 in half-second increments).

When a change is selected, but not yet saved, the value blinks.

Press **ENTER** to save the selection to memory.

Press **MENU** to go to Menu #0 and then **ENTER** to go back to the Default Menu.

*If audio is being switched with the video, the audio will also be delayed.*

Press **MENU**, **ENTER** to go back to the Default Menu.

### 5. Slave Configuration Menu

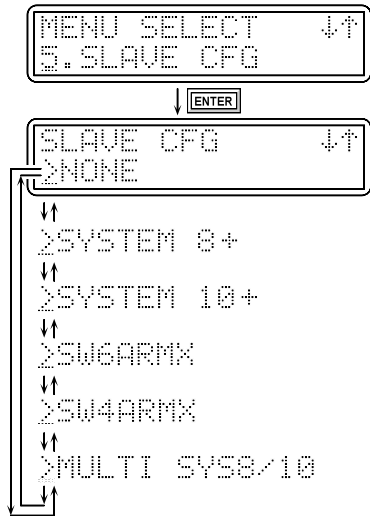

Use **[MENU]** **[▼]** **[▲]** to get to this menu, and then press **[ENTER]** to select it.

Menu 5 is used **only** to set up the System 4*xi* for use with a slave switcher. The default setting is "None".

Press **[▼]** or **[▲]** to select from the following options:

- None = The System 4*xi* has no slave inputs.
- System 8+ = The slave is a System 8 Plus.
- System 10+ = The slave is a System 10 Plus.
- SW6ARMX = The slave is an SW6 ARMX switcher.
- SW4ARMX = The slave is an SW4 ARMX switcher.
- MULTI SYS8/10 Plus = More than one System 8/10 switcher.

Press **[ENTER]** to save the selection to memory.

Once set for a slave, an 8th menu will become available for selecting slave channels. See Chapter 4 for details on slave configurations.

Press **[MENU]** to go to Menu #0 and then **[ENTER]** to go back to the Default Menu.



*When looped with other switchers, the System 4*xi* is **always** the Master. System 4*xi* switchers cannot be looped together.*

### 6. LD Sync Configuration Menu\*

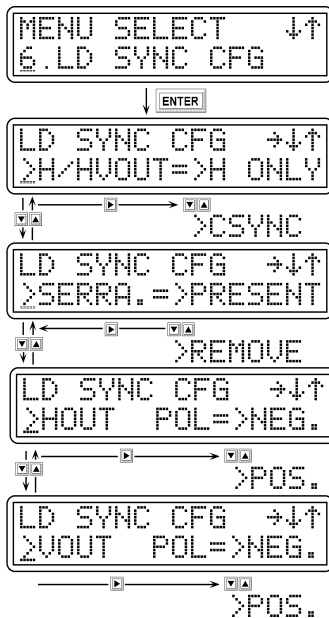

This menu specifies line-doubled/quadrupled sync output format.

Use **[MENU]** **[▼]** **[▲]** to get menu 6, and then press **[ENTER]** to select it.

There are four submenus for menu 6. Each submenu has two selection points, indicated by the character ">". Use **[▶]** to step between the two selection points, and then use **[▼]** or **[▲]** to change the choices.

H/HVOUT => H Only for separate H & V out or CSync for composite sync out.

SERRA.=> set for Serration Pulses Present or Removed.

HOUT POL=> to set Horizontal Sync for Positive or Negative Polarity.

VOUT POL=> to set Vertical Sync for Positive or Negative Polarity.

If a change is selected, the new selection blinks until it is saved.

Press **[ENTER]** to save the new setting.

Press **[MENU]** or any input button at any time to exit.

Press **[MENU]** to go to Menu #0 and then **[ENTER]** to go back to the Default Menu.

\*LD*xi* is shown here

### 7. Sync Configuration Menu

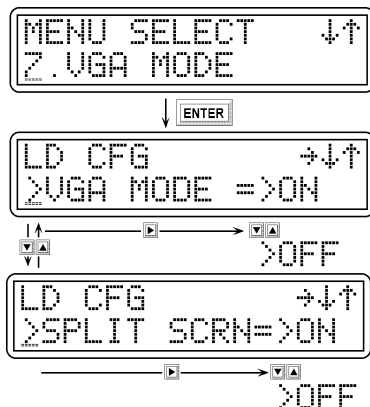

This Menu 7 will set up Line-Doubler/Line Quadrupler display mode for System 4LD*xi*/4LQ*xi* (see flowchart in Figure 3-7 for menu differences).

Press **[MENU]** **[▼]** **[▲]** to access this menu, and then press **[ENTER]** to select it.

With the cursor in the left position, use **[▼]** or **[▲]** to select VGA Mode or Split Screen (also called "Demo mode").

With the cursor at the right position, use **[▼]** or **[▲]** to turn the selected function On or Off.

Press **[ENTER]** to accept/save the change.

Press **[MENU]** to go to Menu #0 and then **[ENTER]** to go back to the Default Menu.



### 8. Information Menu

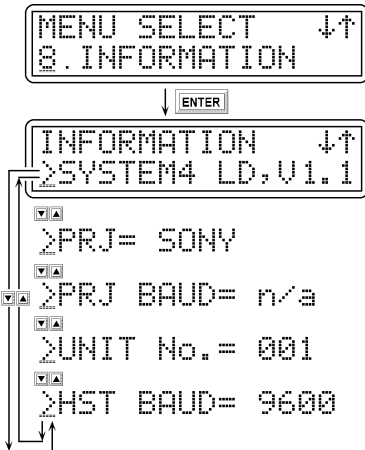

Use **MENU** to get this menu, and then press **ENTER** to select it.

Menu 8 allows the internal system information to be displayed on the LCD screen, eliminating the need to open the System 4<sub>xi</sub> cover to see the switch settings. The Information Menu is for **display only**; no changes can be made from here.

Press **ENTER** to select this menu set.

The five submenus are shown in the example to the left.

Press or to step through and display the information choices.

The diagram to the left shows some examples of what the settings could be.

Press **MENU** or any input button at any time to exit.

Press **MENU** to go to Menu #0 and then **ENTER** to go back to the Default Menu.

### 9. Slave Switcher Input Selection

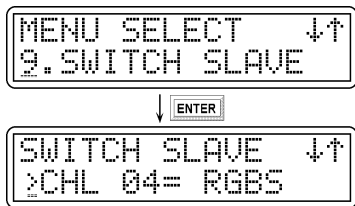

If the System 4<sub>xi</sub> is not set up for a Slave input, this menu will not appear.

Because the System 4<sub>xi</sub> has four input buttons, if it uses a slave switcher, Menu 9 is used to select a Slave input from the Front Panel. Use the or buttons to select from Input 4 through the highest input number available. (e.g. If a System 8 PLUS switcher is used as a slave, the input channels available in Menu 9 will be 4 through 11.)

When the input is selected, its video format is also displayed.

Press **ENTER** to select the displayed channel.

Press **MENU** to go to Menu #0 and then **ENTER** to go back to the Default Menu.



*CHL represents the input channel number (CHL04). In menus 1 and 2, VID (VID04) and AUD (AUD04) are used because in those menus video and audio are handled separately.*

### Picture Controls (line doubler/line quadrupler converter)

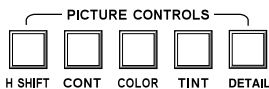

The number of Picture Controls depends upon the System 4<sub>xi</sub> model. (See Figure 3-2.) Each Picture Control button will display its current setting. From this display, adjustments can be made and saved.



*There are three ways to exit a display at any time, without saving new settings.*

1. Press the same Picture Control button.
2. Press any input button (1 thru 4).
3. Press **MENU** to go to Menu #0 and then **ENTER** to go to the Default screen.



*Picture Controls for CONT, COLOR, and TINT are not available for RGLD/ RGLQ inputs.*

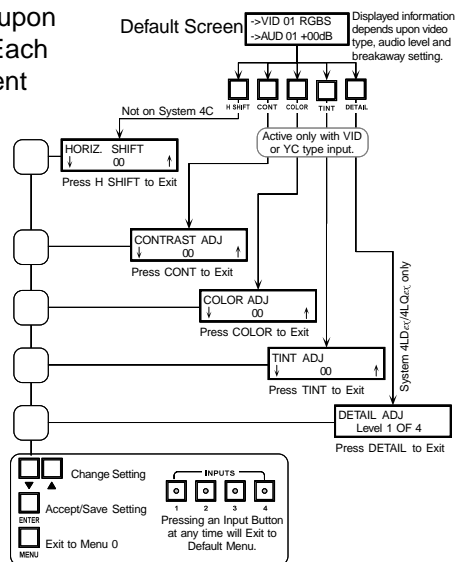





Figure 3-6. System 4<sub>xi</sub> Picture Controls Display Menu Flowchart

### Horizontal Shift Control



This is for line doubled/line quadrupled signals only.

Press **H SHIFT** to bring up this menu. The current Horizontal Shift setting will be displayed. Use  or  to change the setting, while observing the projector/monitor screen. (Range: -62 to +62).



Press  to save the new setting.

Press **H SHIFT** again to exit and return to the default screen.

To exit without saving, press **H SHIFT** again (without pressing ), or use one of the other procedures above.

### Contrast Control





Press **CONT** to display this menu. The current Contrast setting will be displayed. Use  or  to change the setting, while observing the projector/monitor screen. (Range: -62 to +62).

Press  to save the new setting.

Press **CONT** again to exit and go to the default screen.

### Color Control





Press **COLOR** to display this menu. The current Color level will be displayed. Use  or  to change the setting, while observing the projector/monitor screen. (Range: -62 to +62).

Press  to save the new setting.

Press **COLOR** again to exit and go to the default screen.

### Tint Control



Press **TINT** to display this menu. The current Tint (Hue) level will be displayed. Use  or  to change the setting, while observing the projector/monitor screen. (Range: -62 to +62).



Press  to save the new setting.

Press **TINT** again to exit and go to the default screen.

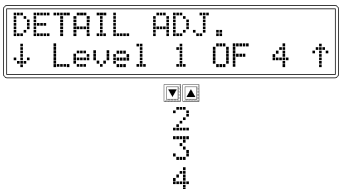
### Detail Control



This control is only on the System 4LD*xi* and 4LQ*xi*

Press **DETAIL** to display this menu. The current Detail (Sharpness) setting will be displayed. Use  or  to change the setting, while observing the projector/monitor screen. (Range: 1 to 4).

Press  to save the new setting.

Press **DETAIL** again to exit and go to the default screen.

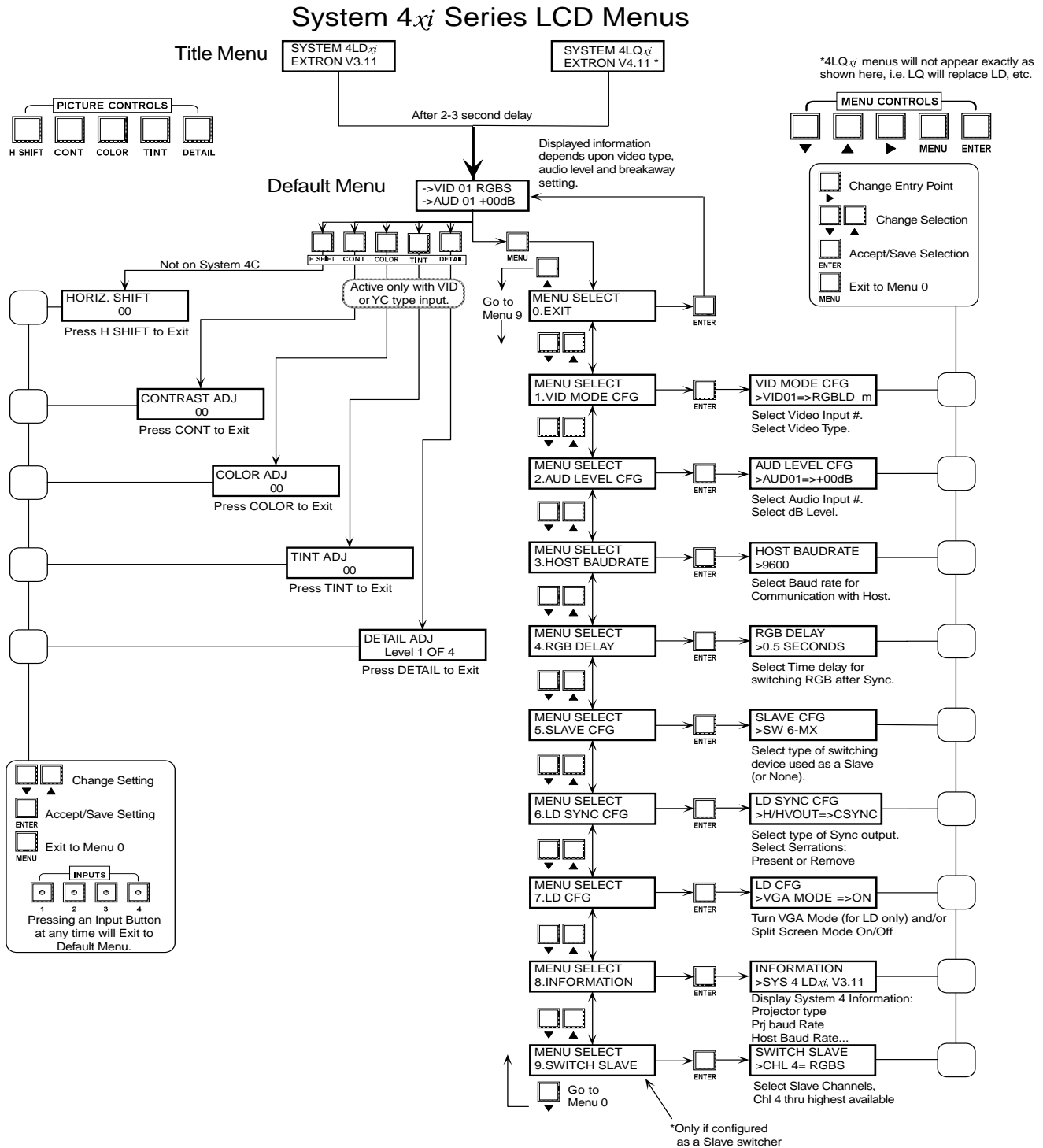





Figure 3-7. System 4<sub>xi</sub> Display Menu Flow Chart

## Special Functions

Other functions that can be accessed, using the Front Panel, are described below.

### System Reset

The System 4*x*i can be restored to factory settings at any time from the default menu. To do this from the default menu, press and hold  and  and  at the same time until a reset display message appears in the LCD screen. See the example below. When finished, the Default screen reappears.



*This operation destroys all settings that were saved to memory, including all slave configuration settings.*

```
Resetting SYSTEM
Please Wait.....
```

```
Resetting MODE
Please Wait.....
```



```
Resetting VALUE
Please Wait.....
```

The restored settings include:

- Video configuration = RGBS
- Audio = 0.0 dB
- H Shift = midpoint (0)
- Cont = midpoint (0)
- Color = midpoint (0)
- Tint = midpoint (0)
- Host baud rate = 9600
- RGB delay = 0.0 seconds
- LD-Sync Cfg:
  - Out = Composite Sync
  - Serration = Present
- Number of channels = 4 (no slaves)

### Toggle Executive Mode

```
*VID 01 RGBS
*AUD 01 +00dB
```

Executive Mode allows certain settings to be protected by locking out the Front Panel. To toggle Executive Mode On from the default menu, press  and  at the same time. Hold the keys until the LCD display indicates the mode change. The second line of the LCD display will temporarily change to show "Executive ON".

When the System 4*x*i is in the Executive Mode, panel operation is limited to Channel Input keys and Audio Mute keys. The Default LCD screen will change, showing "\*" instead of "→". The VID and AUD information will be the same as the standard Default display.



*One of the benefits of Executive Mode is that it stays in effect when power is turned Off.*

```
+VID 01 RGBS
+AUD 01 +00dB
```

The same procedure toggles Executive Mode Off. From the default menu, hold the keys until the LCD display indicates the mode change. The second line will temporarily change to show "Executive OFF". The Default display changes the symbols "\*" back to "→".

# **System 4<sup>xi</sup> Switcher Series User's Manual**

---



## **Chapter Four**

### **Connecting Multiple Switchers**

*Looping the System 4<sup>xi</sup> (Master/Slave)*

*Input Channel Addressing*

*SW4 ARMX or SW6 ARMX as Slave to System 4<sup>xi</sup>*

*System 8/10 PLUS as Slave to System 4<sup>xi</sup>*

*Multiple System 8/10 PLUS Switchers*

## Looping the System 4*x*i with Other Switchers

The System 4*x*i can be interconnected, or “looped” with other switchers to allow for a greater number of inputs to be switched to the projector. With each of these configurations, the System 4*x*i acts as the “Master”, to communicate with the projector and supply the video signal. The switcher that provides input to the System 4*x*i is the “Slave”. If two switchers are looped with the System 4*x*i, the second switcher is a “Slave” to the first, and the first is a “Slave” to the System 4*x*i.

- The slave switcher is always connected to the highest master input (input #4 on a System 4*x*i, input #10 on a System 10 and input #8 on a System 8, etc.).
- Input numbering always starts at input #1 of the System 4*x*i and input #4 will become the first input from the “slave” switcher.
- The System 4*x*i **cannot** be used as a slave switcher.
- The only switchers that can be looped with the System 4*x*i are:  
Extron’s SW4 ARMX, SW6 ARMX, System 8 PLUS and System 10 PLUS.
- In any master/slave arrangement, the System 4*x*i acts as if it is one large switcher. That is, each slave input can be selected and set up from the System 4*x*i Front Panel. Any Slave input can be configured for any signal type.  
For example, a System 4LD*x*i with a System 8 PLUS as a slave is seen by PC software as a line-doubling, 11-input switcher.

## Input Channel Addressing

The System 4*x*i must be set up to recognize input that is from another switcher unit. The Front Panel operation in Chapter 3 explains how this is done. In a master/slave configuration, input channel numbers of 4 or higher are translated and sent to the appropriate slave input number. For example, selecting input #9 will select input #4 on the System 4*x*i, and then tell the slave switcher to select its input #6. See shaded table entry below.

Channel	Sys4	SW4	SW6	SW8+	SW10+	Multiple SW8+/SW10+
Ch #1	Ch #1					
Ch #2	Ch #2					
Ch #3	Ch #3					
Ch #4	Ch #4	Ch #1	Ch #1	Ch #1	Ch #1	Ch #1 (1st SW10)
Ch #5	Ch #4	Ch #2	Ch #2	Ch #2	Ch #2	Ch #2
Ch #6	Ch #4	Ch #3	Ch #3	Ch #3	Ch #3	Ch #3
Ch #7	Ch #4	Ch #4	Ch #4	Ch #4	Ch #4	Ch #4
Ch #8	Ch #4		Ch #5	Ch #5	Ch #5	Ch #5
Ch #9	Ch #4		Ch #6	Ch #6	Ch #6	Ch #6
Ch #10	Ch #4			Ch #7	Ch #7	Ch #7
Ch #11	Ch #4			Ch #8	Ch #8	Ch #8
Ch #12	Ch #4				Ch #9	Ch #9
Ch #13	Ch #4				Ch #10	Ch #10
Ch #14	Ch #4					Ch #2 (2nd SW10)
Ch #15-22*	Ch #4					Ch #3 - 10

\* Channel numbers continue if multiple switchers are used as slaves. The highest number of channels is 22, using two System 10 PLUS units as slaves.

The following pages show configurations for looping the System 4*x*i with other Extron-approved switchers. Looping the System 4*x*i will not work with all switchers; call Extron Electronics if you have any questions.

### Controlling Master/Slave Switchers

When a host system is controlling a System 4<sub>xi</sub> with a switcher as a slave, a special 9-pin T-Connector cable, called a “System 4<sub>xi</sub> Slave Adapter” is necessary. Pictured below, in Figure 4-1, the connector marked “Slave” is a 9-pin male connector designed to work with the switchers described in this section.

Communications between the System 4<sub>xi</sub> (master) and the slave is done through a second port on the same connector. The adapter puts this second set of signals on the “normal” transmit/receive lines (pins 2 and 3) on the slave connector. Because Host devices tend to use pins 4 and 8 for CTS and DTR signaling, those pins must be disabled.

△ ————— Referred to as Rx2 and Tx2, on pins 4 and 8, these pins\* must not be used for other signals in the Host System. It may be necessary to disconnect pins 4 and 8 at the Host side.

The J1 connector connects to the J2 connector which connects to the J3 connector.

J1 Pins (System 4 <sub>xi</sub> )	J2 Pins (Host)	J3 Pins (Slave Switcher)
1 - n/c	1 - n/c	1 - n/c
2 - Tx	2 - Rx	2 - Tx2 (slave to host)
3 - Rx	3 - Tx	3 - Rx2 (host to slave)
4 - Tx2	4 - *Tx2	4 - n/c
5 - Gnd	5 - Gnd	5 - Gnd
6 - n/c	6 - n/c	6 - n/c
7 - n/c	7 - n/c	7 - n/c
8 - Rx2	8 - *Rx2	8 - n/c
9 - n/c	9 - n/c	9 - n/c

Extron makes this cable (Extron part # 26-386-01), however, if you choose to make your own, the pin requirements are specified in the above table.

The System 4<sub>xi</sub> Slave Adapter is shown in the appropriate application diagrams that follow.

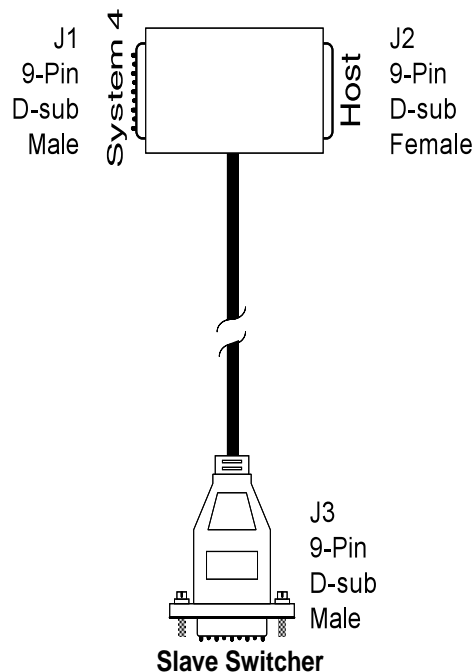

Figure 4-1. System 4<sub>xi</sub> Slave Adapter

System 4<sub>xi</sub> with SW4/6 ARMX Switchers

The picture in Figure 4-2 shows an SW6 ARMX as an example, although it would also apply to an SW4 ARMX. Connect the video output of the ARMX switcher (SW4 or SW6) to the last (4th) input of the System 4<sub>xi</sub>.

Regardless of how the slave switcher input connectors are marked, they must conform to the inputs of the System 4<sub>xi</sub>. They are: R/C, G/Y/Video, B, H/HV & V. Note that composite video uses the G/Y connector.

The System 4<sub>xi</sub> will control the ARMX switcher through the secondary RS-232 port, by way of a System 4<sub>xi</sub> Slave Adapter described on page 4-2.

Jumper E2 inside the SW4/6 must be moved from "Normal" to "Slave Sys4" position to allow it to act as a slave. (See SW4/6 documentation.)

After making all the cable connections, go to page 4-7 to configure the master/slave as a system.

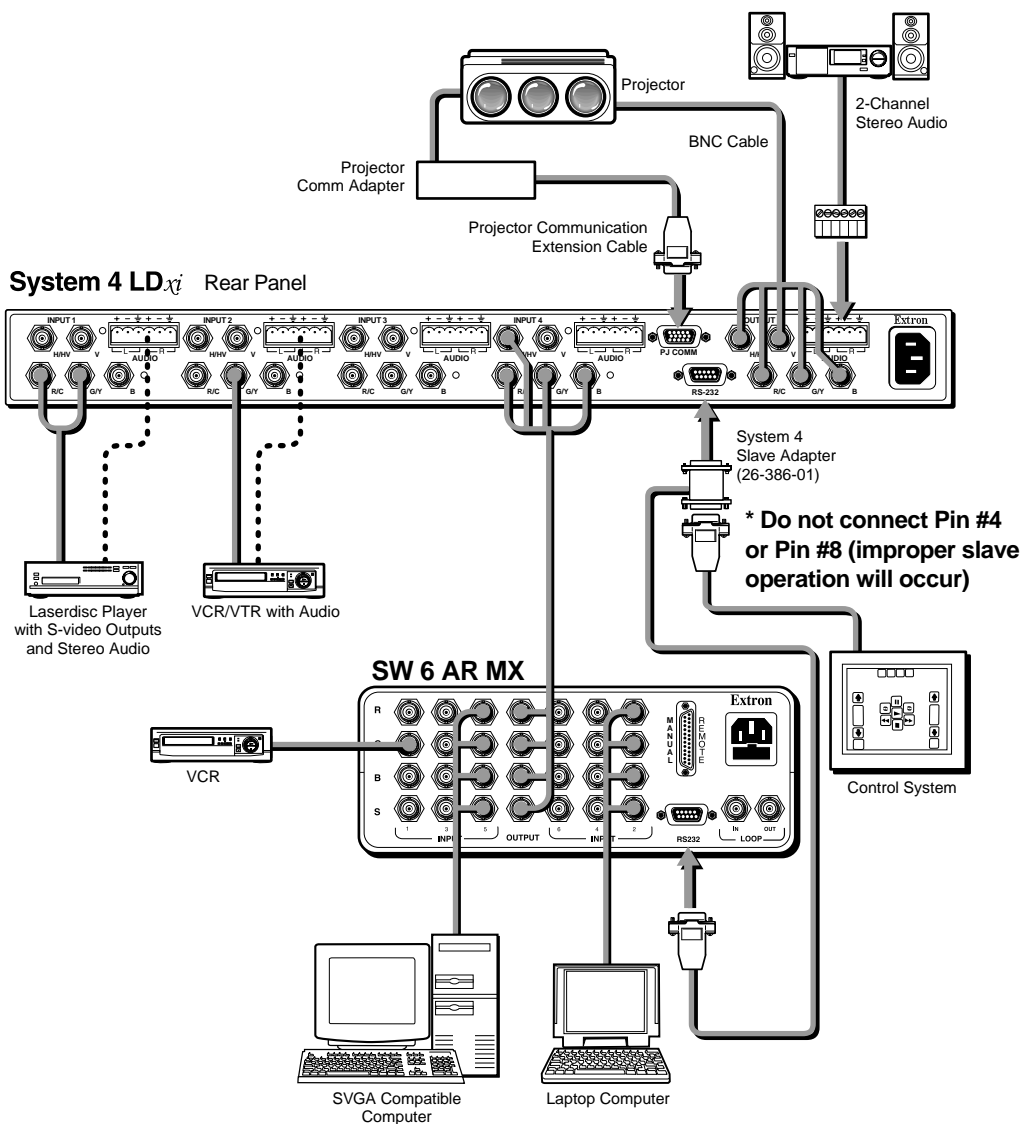

Figure 4-2. System 4<sub>xi</sub> Master with an SW6 ARMX Slave Switcher



### System 4<sub>xi</sub> with One System 8/10 Plus Switcher

The System 8/10 Plus must be configured as a Slave. Connect the RGBHV and Audio output of the System 8/10 Plus switcher to the last (4th) input of the System 4<sub>xi</sub>. Use the figure below as an example.

The System 4<sub>xi</sub> will control the System 8/10 Plus Switcher through the secondary RS-232 port, by way of a System 4<sub>xi</sub> Slave Adapter described on page 4-2.

Go to page 4-6 to set up the System 8/10 Plus switches.

After making all the cable connections, go to page 4-7 to configure the master/slave as a system.

#### System 4 LD<sub>xi</sub> Rear Panel

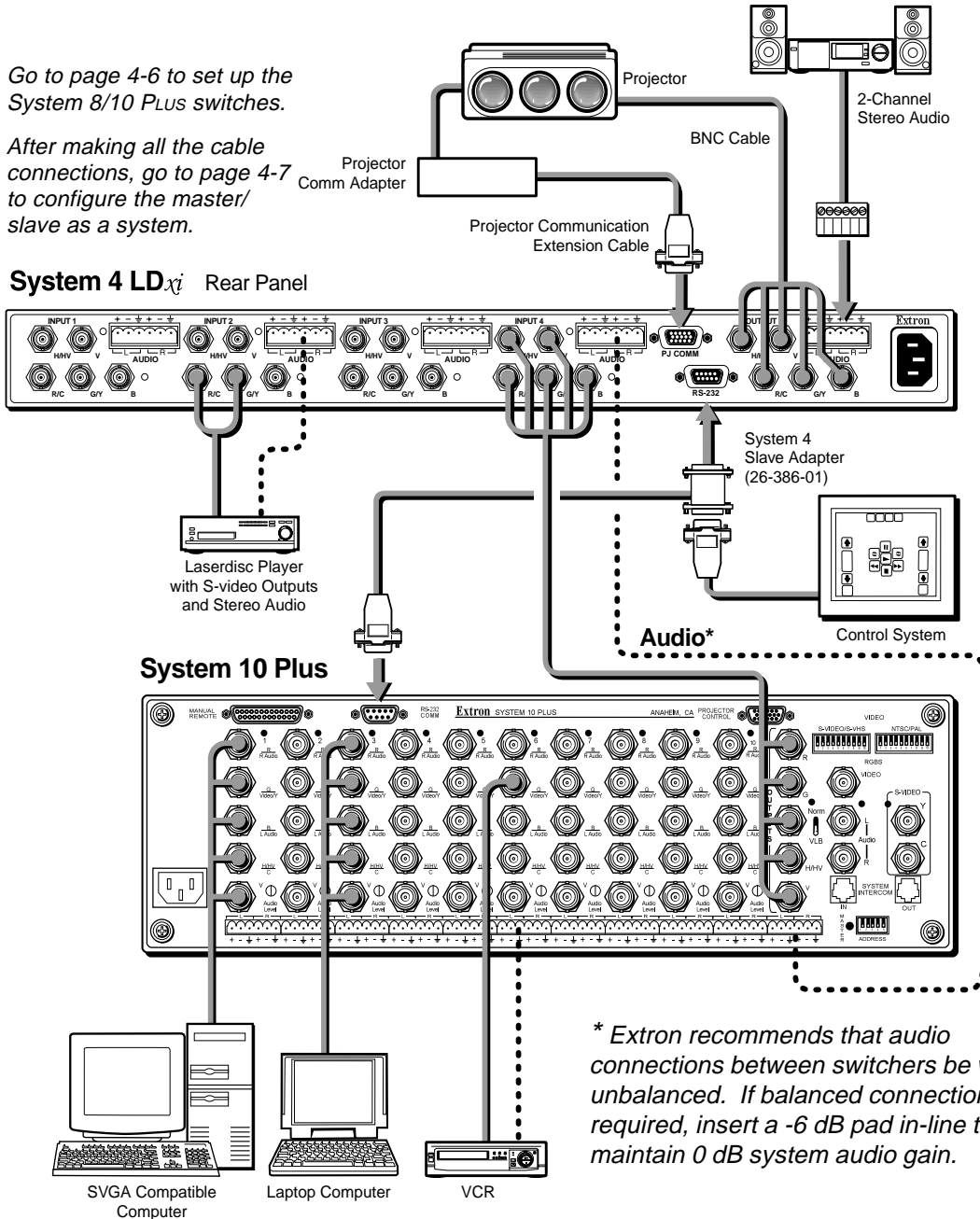

Figure 4-3. System 4<sub>xi</sub> Master with a System 10 Plus Slave Switcher

Regardless of how the slave switcher input connectors are marked, they must conform to the inputs of the System 4<sub>xi</sub>. They are: R/C, G/Y/Video, B, H/HV & V. Note that composite video uses the G/Y connector.

**System 4<sub>xi</sub> with Multiple System 8/10 PLUS Switchers**

This configuration will work only with System 8/10 PLUS switchers in a daisy chain configuration. (See the System 8/10 PLUS User's Manual for details.) The master of the System 8/10 PLUS chain must be configured in the "RS-232 only" projector communications mode. The System 4<sub>xi</sub> will control the System 8/10 PLUS Switcher through the secondary RS-232 port by way of a System 4<sub>xi</sub> Slave Adapter described on page 4-2. The System 4<sub>xi</sub> communicates with the first System 8/10 PLUS, which in turn communicates with the second System 8/10 PLUS.

A. Use the Slave Adapter to connect the controlling device to the System 4<sub>xi</sub> and to the first System 8/10 PLUS.

B. Connect a cable from Intercom Out connector (RJ11) on the first System 8/10 PLUS and the other end into Intercom In connector (RJ11) of the second System 8/10 PLUS.

C. Connect the RGBHV and Audio outputs from the System 8/10 PLUS master to the last input of the System 4<sub>xi</sub>. Likewise, connect the output of the second slave to the last input of the first slave.

Go to page 4-6 to set up the System 8/10 PLUS switches.

Regardless of how the slave switcher input connectors are marked, they must conform to the inputs of the System 4<sub>xi</sub>. They are: R/C, G/Y/Video, B, H/HV & V. Note that composite video uses the G/Y connector.

After making all the cable connections, go to page 4-7 to configure the master/slave as a system.

\* Extron recommends that audio connections between switchers be wired unbalanced. If balanced connections are required, insert a -6 dB pad in-line to maintain 0 dB system audio gain.

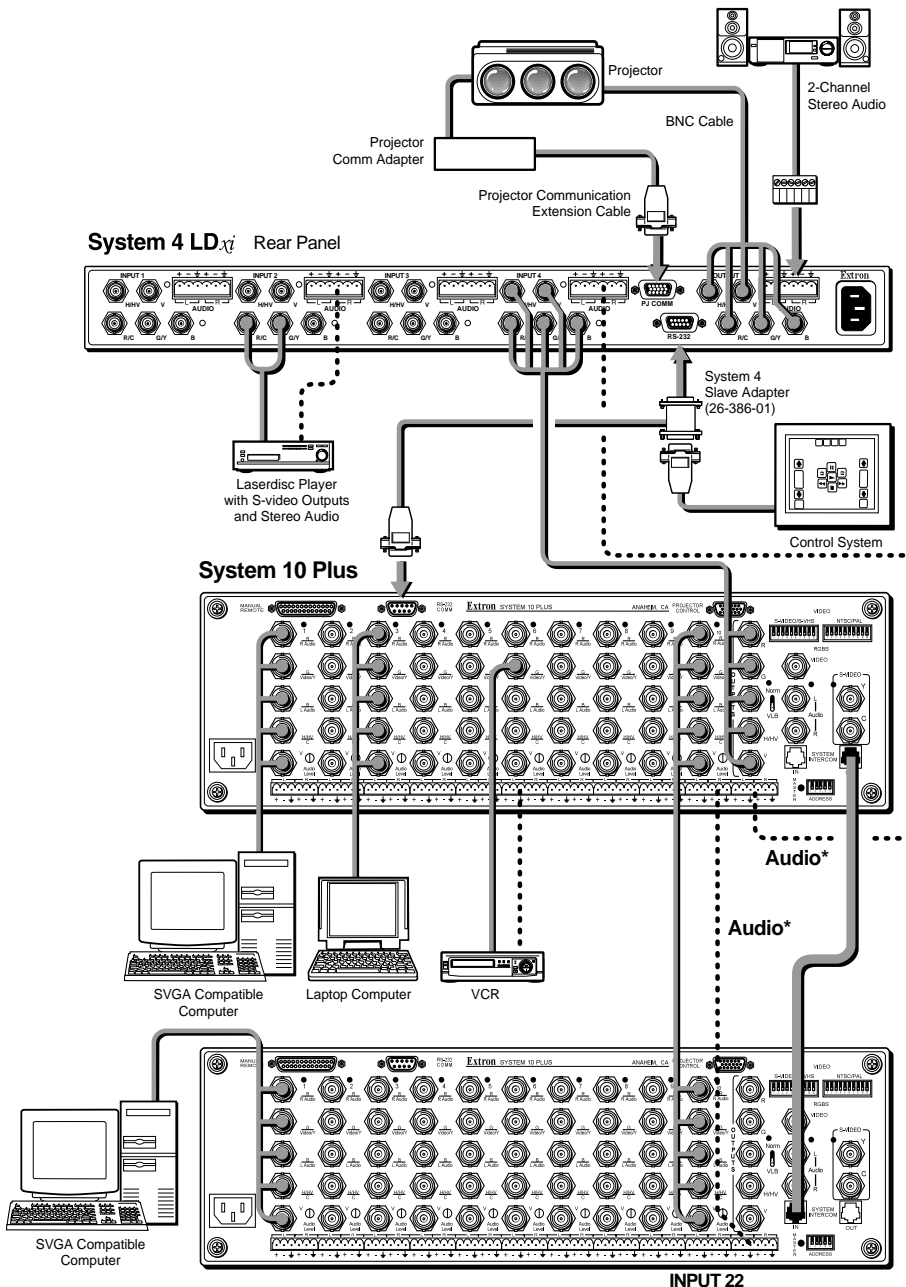

Figure 4-4. System 4<sub>xi</sub> Master with multiple System 10 Plus Slave Switchers

### System 8/10 Plus Switch Settings

From the front access panel on the System 8/10 Plus, do the following:

1. On DIP switch block SW15, set switches #6 and #8 ON.

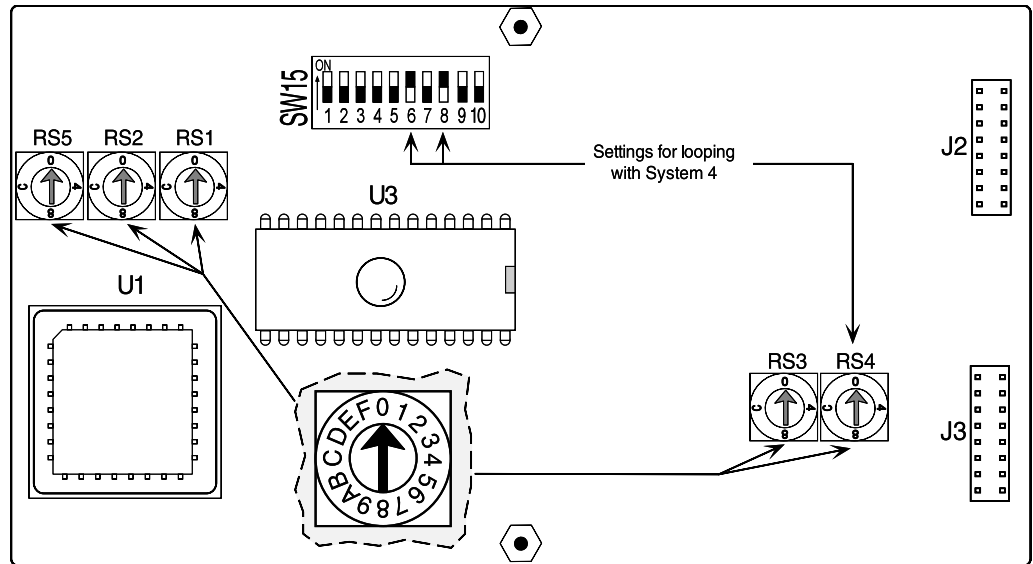

Figure 4-5. System 8/10 Plus Front Access Panel Switches

2. Set rotary switch RS4 to the "0" position.

On the rear panel of the System 8/10 Plus, do the following:

3. Set the Norm/VLB switch on the back of the 8/10 Plus set to "Norm".
4. Set the Address switches for "master". (If looping two 8/10 Plus systems to the System 4<sub>x</sub>, the second one must be set as a "slave".)
5. Set the Video/RGBS switches to match the type of video to be used by each input and do the configuration setup.

Go to page 4-7 to configure the master/slave as a system.

Refer to the System 8/10 Plus User's Manual for other switch settings.

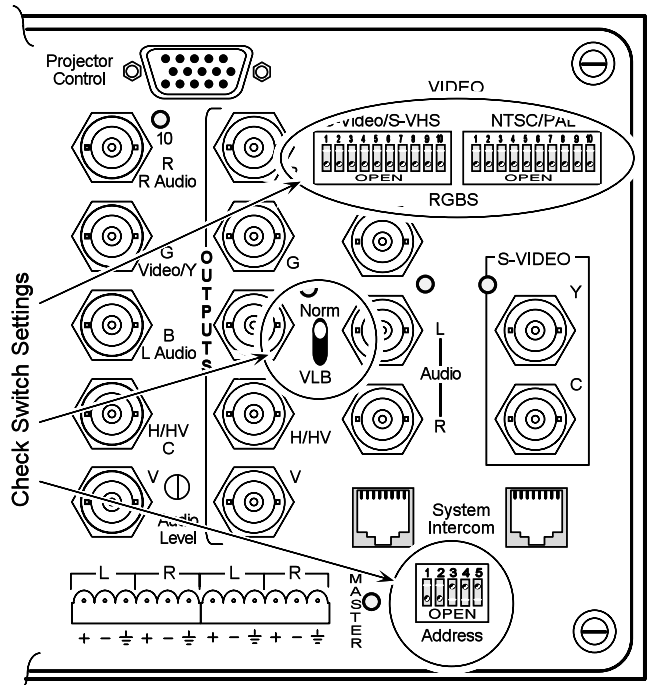





Figure 4-6. System 8/10 Plus Setup Switches

## Programming the System 4<sub>xi</sub> Looping Configuration

After making all the connections for a master/slave system, turn power on for all the units involved and access Menu 5 (Slave Cfg). Use the  or  to step to the correct configuration, and then press  to save the setting to memory.



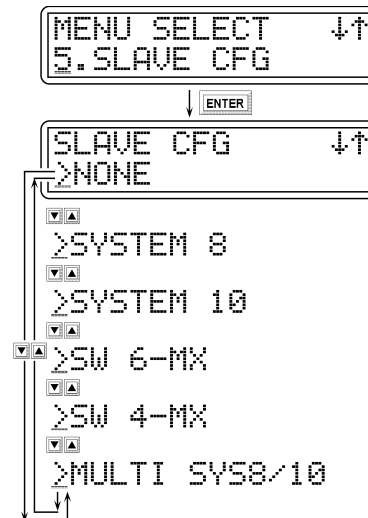

*This procedure may be done before connecting the slave(s) to the System 4<sub>xi</sub>, if that is more convenient.*



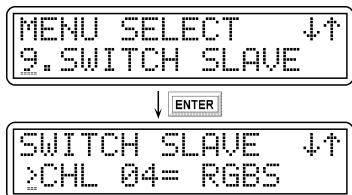

## Testing the Master/Slave Communications

Press  to go back to the menu selection again. Step to the Switch Slave menu (Menu 9 if System 4LD<sub>xi</sub>/4LQ<sub>xi</sub> – otherwise Menu 8). This menu will only appear if there is a slave configured.



Press  to get the Switch Slave Menu (shown below). The display will show Channel 4 because that is the first slave channel.

Use the  and  to step to a slave channel and press  to select it. Once selected, look at the front panel of the slave unit to see that the correct channel has been selected. Using the table on page 4-1, select channel #6 and channel #3 will light on the slave switcher. Repeat this procedure for each available slave channel. (Only the available channels will show in the LCD display.)

Now test the switcher communications in reverse by pressing a channel switch on the slave and see that its system channel number appears in the LCD display. Again, use the table on page 4-1 as a reference.

Once the master/slave system is checked out, all of the available channels can be accessed and set up from the System 4<sub>xi</sub> front panel with Menus 1 and 2. The channel numbers will be as listed in the left column of the table on page 4-1.



*Resetting the system (described on page 3-7) will remove all slave channels from memory. If that happens, Menu 5 must be used to reconfigure the system.*

# **System 4<sub>xi</sub> Switcher Series User's Manual**

---



# 5 Chapter Five

## **Using Windows® Control Software**

*Installing the Windows Software*

*Using Help Examples*

*System 4<sub>xi</sub> Stand-alone*

*System 4<sub>xi</sub> with Slave*

*Executive Mode*

## Extron System Switcher Control Software

This chapter is dedicated to using Extron's "Windows Control Program for System Switchers via RS-232" software. Extron supplies this software that runs in the Windows® operating system, version 3.1 or later (Windows95® and Windows98®). It works with several Extron system switchers, including the System 4*x*i series. Communication between the computer software and the switcher is established after connecting the computer to the RS-232 Port on the rear panel of the System 4*x*i, as follows:

1. Connect the PC's Comm port to the RS-232 on the back of the System 4*x*i.
2. Power up the System 4*x*i and the PC and start Windows.

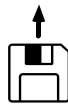

The floppy disk has instructions printed on the label. The software can be run from the floppy drive, or loaded onto the PC's hard drive.

3. Install the software from the 3.5" floppy disk onto the hard disk like any other Windows application. (Run Setup.exe from the floppy disk.)



Although this software was designed to control any System 4*x*i switcher, its operation will be restricted to the features and configuration of your unit.

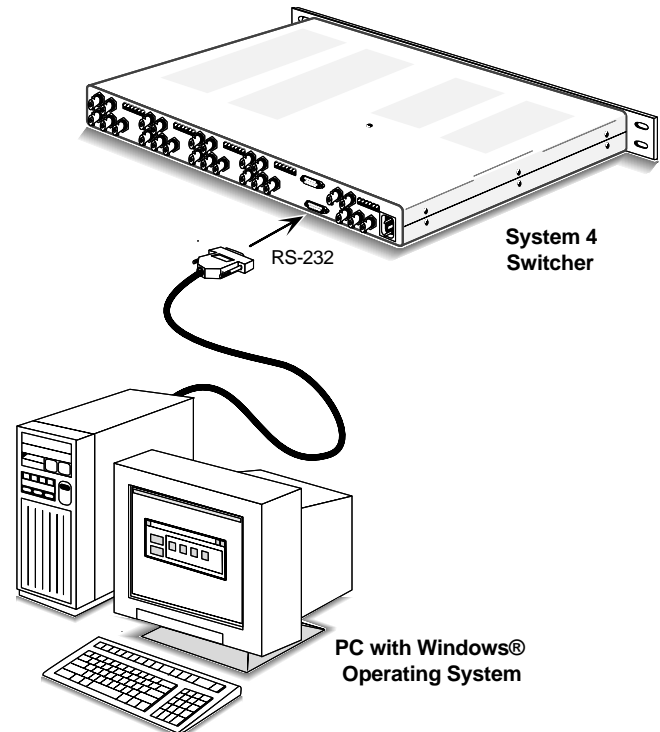
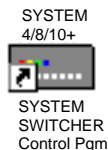

Figure 5-1. Connect the PC to the System 4*x*i.



4. To run the System Switcher Control program, double-click on the SYSTEM SWITCHER Control Pgm icon in the Extron Electronics group or folder. The Comm menu appears on the display.

Figure 5-2. System Switcher Control Program icon



Double-clicking the Help icon will present detailed examples of the screens and menus prior to running the Control program.

5. After you have selected the Comm Port, the software looks for the System 4*x*i, "reads" its configuration, and then displays that information in a window called "Extron's System Switcher Control program". (see Figures 5-4 through 5-7)

## System 4<sub>xi</sub> Help

The fastest way to learn what each Windows® function does is through the Help menus. At any time, help is available by double-clicking the Help icon (previous section), pulling down the Help menu or by pressing F1. This will bring up the Help menu (like the example shown below) to allow you to step through the screen examples. Click on the items on each screen to display a description.



As with all Windows® Help menus, clicking on the underlined words will give more detailed help.

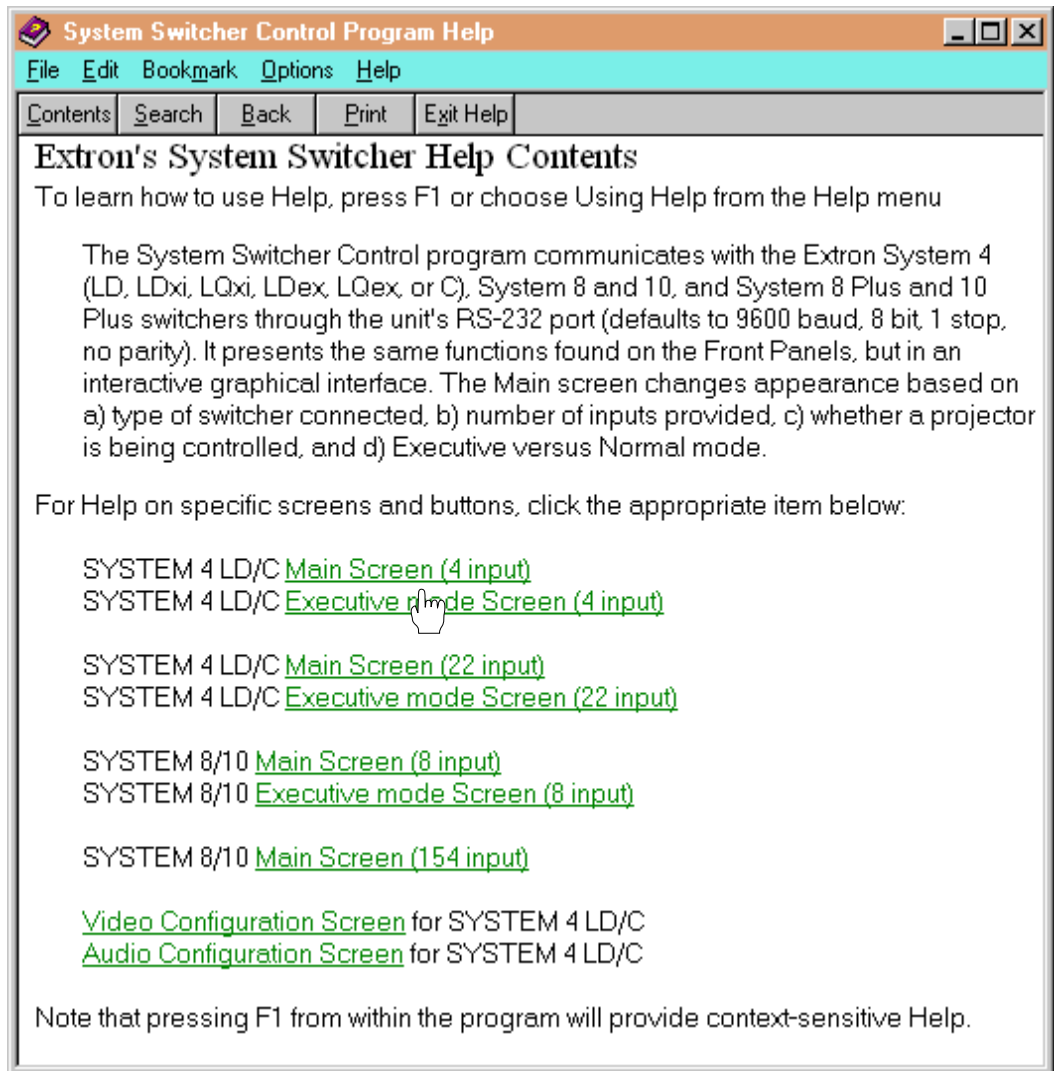

**Figure 5-3. Example of the first Help menu, Help Contents**

After viewing the Help menus, use the software to setup your System 4<sub>xi</sub>. Specific examples are given below.

Each function on the front panel of your System 4<sub>xi</sub> is emulated in the software panel in the window. Also, the software was written to operate with different models of switchers. Therefore, any function that is not available on your model will be inactive in the window. A function is inactive when it appears dull, or gray, and does not respond to the mouse cursor.

*Windows Control Panel Examples:*

As mentioned earlier, the window panels have the same functions as the System 4*x*<sub>i</sub> front panel. Figure 5-4 shows four input buttons for the System 4*x*<sub>i</sub>, while Figure 5-5 shows 11 inputs. This is an example of a System 4*x*<sub>i</sub>, with a System 8 Plus switcher as a slave unit. Inputs 1, 2 and 3 may each have a video device connected. However, Inputs 4 through 11 are actually Inputs 1 through 8 of the slave switcher connected to the System 4*x*<sub>i</sub> (8 + 3 = 11 inputs).

Although the Help menus have detailed information on the software functions, here are some brief descriptions.

**MAIN POWER** – in the upper-left corner, is the same as the Power button on the System 4*x*<sub>i</sub> front panel. It turns the switcher off or on.

 When this button is in the off position, power is still present inside the System 4*x*<sub>i</sub> enclosure.

**INPUTS** – Click to select an input. Settings associated with that input will also be displayed in the window panel. If both the Video (green) and Audio (blue) boxes are selected (X), the audio and video will switch together (Audio Follow); if not, they may be switched separately (Breakaway).

The Video type (example VIDLD\_s) and Audio level (example +14 dB) are displayed to the right of the buttons.

**AUDIO MUTE** – This button mutes the Audio temporarily.

**DISPLAY POWER** – This button is the same as the Display Power button on the System 4*x*<sub>i</sub> front panel. If available, it turns the display (projector) off or on.

**DISPLAY MUTE** – This button, if available, turns the display (picture) off temporarily.

**FREEZE** – Freeze Frame Mode is active if this LED is on. While in this mode, the output will be a single frame of video until the Freeze button is pressed.

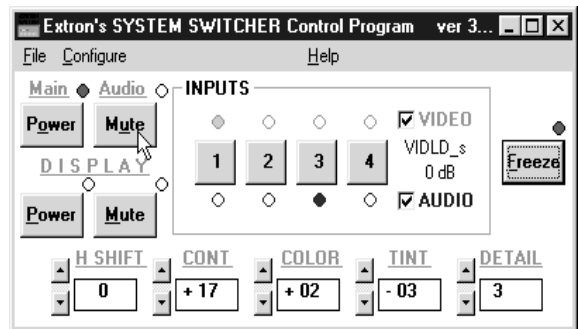

Figure 5-4. Example of a System 4*x*<sub>i</sub> (LD/LQ) Panel with no Slave Switchers

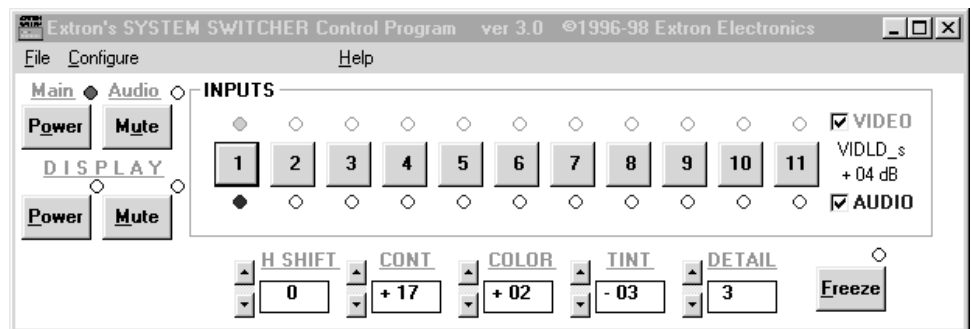

Figure 5-5. Example of a System 4*x*<sub>i</sub> (LD/LQ) Panel with a System 8 Plus as a Slave Switcher



**PICTURE CONTROLS** – Depending upon the model of your System 4.xi, there are three, four or five controls that correspond to the Picture Controls on the System 4.xi front panel. Each control is clearly marked and has a “nudge” button for increasing and another for decreasing the setting. (These controls are also available through the Configure Video pull-down menu.



The actual window panel controls will depend upon your System 4.xi model, as well as the projector, or display device that is connected to it.

## Executive Mode

This section shows examples of System 4.xi panels when in Executive Mode. After setting up the audio and video controls, the System 4.xi may be put in Executive Mode. This simplifies switcher operation by disabling most of the audio and video setup controls and not displaying them. This mode also “locks” configuration settings by not allowing access to them.

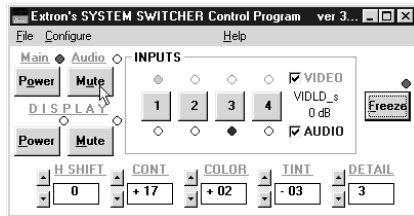

Figure 5-6. Example of a System 4.xi (LD/LQ) Panel in Executive Mode with no Slave Switchers

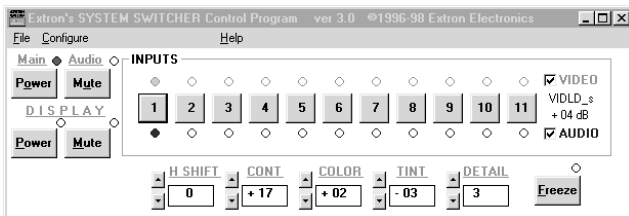

Figure 5-7. Example of a System 4.xi (LD/LQ) Panel in Executive Mode with a System 8 Plus as a Slave Switcher

Enter Executive Mode from the Configure Menu; leave by clicking on the Normal button.

Executive Mode takes up less space on the computer screen, allowing space for other applications.

Use the Normal button to get out of Executive Mode and return to the type of menus shown on page 5-3. Use the Exit button to close and exit the Windows® Control Software.

## Window Pull-Down Menus

The following menus are not available in Executive Mode:

**FILE MENU** – Use the Help menu for descriptions. Selections include:

- *Initialize Unit* – Reset the System 4.xi to factory settings.
- *Test/Cycle Inputs* – Automatically steps through input selection one time.
- *Exit* – Leave the Windows® Control Program.

**CONFIGURE MENU** – Use the Help menu for descriptions. Selections include:

- *Video Modes* – Choose video type, picture controls, etc. for each input. To see an example of this Control Panel Window, select “Video Configuration Screen” from the first Help Screen.
- *Audio Inputs* – Set/view audio levels for each input. To see an example of this Control Panel, select “Audio Configuration Screen” from the first Help Screen.

- *Slaves* – Choose the type of slave switcher input.
- *Sync Configuration* – Choose sync on green, separate sync, etc.
- *RGB Delay* – Set/view time delay value for switching RGB signals after sync.
- *Executive Mode* – Change Windows display to smaller version which locks most controls but allows input switching and on/off control.

**HELP MENU** – Selections include:

- *Contents* – Starts Windows Help.
- *About this program* – Display software version and copyright information.
- *Model* – Identify detected hardware (e.g. System 4LD.x).
- *SC Firmware Version* – Identify Switcher Control firmware version number.
- *PC Firmware Version* – Identify Projector Control firmware version number.
- *Projector* – Identify the projector for which the switcher is set (e.g. Sony).

# **System 4<sup>xi</sup> Switcher Series User's Manual**

---



## **Appendix A**

### **RS-232 Programming Guide**

*RS-232 Interface*

*Simple Instruction Set*

*Advanced Instruction Set*

*Programming Commands*

*Programming Examples*

## Programming the System 4*x*i Series Switchers

This section covers the commands for a host to setup and control a System 4*x*i series switcher through the RS-232 port. The material included covers the System 4LD*x*i and the System 4LQ*x*i switchers. Commands or parameters that apply to specific models will be pointed out, otherwise, all references will simply say "System 4*x*i".

### RS-232 Connections

A standard RS-232 port is available on the back of the System 4*x*i for use by a host system. The connections are as follows:

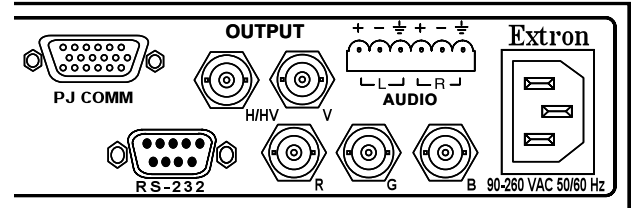

Figure A-1. The RS-232, 9-pin D Connector on the Rear Panel

RS-232 Pin Connections

Pin	Signal	Pin	Signal	Pin	Signal
1	n/c	4	Tx2	7	n/c
2	Tx	5	Gnd	8	Rx2
3	Rx	6	n/c	9	n/c



Rx2 and Tx2 are used to communicate with a slave switcher (do not connect to or use these pins)

### RS-232 Protocol

The default protocol is:

9600 baud, 8-bits, no parity, 1 stop bit and no flow-control.

The baud rate can be changed through a front panel menu. (See Chapter 3.)

### Program Instruction Levels

The System 4*x*i recognizes any character that comes in on the RS-232 port as a possible command. Commands can be from either of two groups, or instruction sets. They are as follows:

1. **The Simple Instruction Set** can be any ASCII character that is recognized by the System 4*x*i as a command. For this set, there are no codes required to say that a command is coming, or that a command has ended. Simple commands could come from a terminal, or any other controlling device. After the System 4*x*i gets the command, it will execute it and send an appropriate response to the controlling device.
2. **The Advanced Instruction Set** consists of more complex instruction strings. Advanced instructions are used when a complete command cannot be defined within one character. Each instruction string must begin with an Escape code (ESC) and end with an End Of Transmission code (EOT). Advanced commands could come from any controlling device capable of composing a command and sending it as a string. The System 4*x*i will execute any legal command string and send a response string back to the host.

Because of this "open recognition", commands from the two instruction sets can be intermixed. Both instruction sets are listed and defined on pages that follow.



RS-232 control can also be established from a computer using the Windows® operating system and Extron's software. This is covered separately in Chapter 5.

## System 4<sub>x</sub><sup>i</sup>-Initiated Messages

When AC power is initially applied to the System 4<sub>x</sub><sup>i</sup>, the following System 4<sub>x</sub><sup>i</sup>-initiated messages (underlined) are sent to the Host:

↓(C)COPYRIGHT 1997, EXTRON ELECTRONICS SYSTEM4LQx<sup>i</sup>, V4.0↓ \*

↓SYS 1↓ System 4<sub>x</sub><sup>i</sup> power is ON

↓Ax↓ x = the Audio channel number selected

↓Vx↓ x = the Video channel number selected

\* *This message will vary depending on the System 4<sub>x</sub><sup>i</sup> model.*

When the Main power from the front panel is applied to the System 4<sub>x</sub><sup>i</sup>, the following System 4<sub>x</sub><sup>i</sup>-initiated messages are sent to the Host:

↓SYS x↓ (as described above)

↓Ax↓ (as described above)

↓Vx↓ (as described above)

When audio and/or video settings are changed using the front panel, the following messages or message combinations are sent to the Host:

↓Ax↓ (as described above)

↓Vx↓ (as described above)

↓Cx↓ Both video and audio settings for channel number x have been changed

When there is a change in the audio gain setting from the front panel, the following message is sent to the Host:

↓RECONFIG↓

## Simple Instruction Set

A simple command may be a single character typed on a keyboard and does not require any special characters before or after. (i.e. It is not necessary to press "enter" from the keyboard.) However, some command characters may be followed by a "delimiter" character which further defines a specific request.

### Related Terms

The following terms may be helpful in understanding information in the tables and examples that follow.

*Delimiter:*

*A delimiter character may specify audio and not video, the switcher and not the projector, etc. For commands that have more than one character, the delimiter is always the last character for that command.*

*Line Feed/Carriage Return:*

*General – On most keyboards, pressing "enter" creates a line feed (lf) and a carriage return (cr). The screen cursor moves down one line (lf) and to the left margin (cr). This is done to prevent stringing unrelated information together. Because these are separate functions, the programmer may send them at any time, and in either sequence (lf/cr or cr/lf). Also, some applications may issue these commands at the beginning of a sequence, at the end of a sequence, or both. Each response (as seen on a terminal display) will use it in one form or another.*

*System 4.xi – The System 4.xi uses lf/cr before and after each response and is symbolized as (↵) in examples that follow.*

*Discrete Command:*

*A "discrete" command can do only one thing. For example, if projector power is already On, sending a "discrete power on" command does nothing. See toggle.*

*Display, or Display Device:*

*"Display" refers to the video output device (projector, monitor, etc.)*

*Host:*

*Any device capable of talking to the switcher through an RS-232 port.*

*Space:*

*When writing programs, it is critical to know when to insert a space and when to leave it out. If not done correctly, the command will not work. Examples in this chapter use a dot (·) to represent a space. This should eliminate any confusion.*

*Switcher:*

*"Switcher" refers to the System 4.xi or any slave inputs from other sources.*

*Terminal:*

*Any device that includes a keyboard and a display. This could be a "dumb" terminal, a "smart" terminal, a PC operating in "terminal" mode, etc.*

*Toggle:*

*A "toggle" command changes the state of the function. This can be either of two things: If the function was Off, the command turns it On; if the function was On, the command turns it Off. A toggle command character may be either upper or lower case.*

*Zero:*

*The number zero may be shown as Ø to distinguish it from the letter "O".*

The codes discussed in this section include any character that may be part of a command or part of a response. This includes delimiter characters, data characters, etc. Some functions may have more than one command. For example, Power has a "turn on", a "turn off" and a "toggle" command.

Simple Instruction List

The table below lists the Simple Instruction Set commands, as well as response and data characters recognized by the System 4<sub>xi</sub>. Examples of their use are given later. The "Cmd/Rsp" column indicates how the character is used: Cmd - indicates a host command (or part of a command) to the switcher. Rsp - indicates a switcher response to the host.

Character	Cmd/Rsp	Dec	Hex	Function
lf	Rsp	10	0A	Line feed
cr	Rsp	13	0D	Carriage return
ESC	Cmd	27	1B	Initiates an Advanced Instruction Set command (Page A-6)
!	Cmd	33	21	Delimiter to specify video and audio selection
\$	Cmd	36	24	Delimiter to specify audio selection only
&	Cmd	38	26	Delimiter to specify video selection only
(	Cmd	40	28	Turn the Display mute On
)	Cmd	41	29	Turn the Display mute Off
+	Cmd	43	2B	Turn the Switcher Audio mute On
-	Cmd	45	2D	Turn the Switcher Audio mute Off
0	Cmd/Rsp	48	30	Numeric value of 0
1	Cmd/Rsp	49	31	Numeric value of 1
2	Cmd/Rsp	50	32	Numeric value of 2
3	Cmd/Rsp	51	33	Numeric value of 3
4	Cmd/Rsp	52	34	Numeric value of 4
5	Cmd/Rsp	53	35	Numeric value of 5
6	Cmd/Rsp	54	36	Numeric value of 6
7	Cmd/Rsp	55	37	Numeric value of 7
8	Cmd/Rsp	56	38	Numeric value of 8
9	Cmd/Rsp	57	39	Numeric value of 9
:	Cmd	58	3A	Turn Executive Mode On (discrete)
;	Cmd	59	3B	Turn Executive Mode Off (discrete)
<	Cmd	60	3C	Turn Switcher Main power On (discrete)
>	Cmd	62	3E	Turn Switcher Main power Off (discrete)
@	Cmd	64	40	Delimiter to specify audio & video for the Switcher only
A	Rsp	65	41	An audio channel character follows
B	Cmd	66	42	Turn RGB mute On for the Switcher only
b	Cmd	98	62	Turn RGB mute Off for the Switcher only
C/c	Cmd	67/97	43/63	Request projector configuration
C	Rsp	67	43	A Channel character follows (audio & video)
E	Rsp	69	45	An Error code character follows
F/f	Cmd	70/102	46/66	Freeze Mode (On/Off)
I/i	Cmd	73/105	49/69	Request for Information
J/j	Cmd	74/106	4A/6A	Demo On/Demo Off
M	Rsp	77	4D	Maximum number of inputs
N/n	Cmd	78/110	4E/6E	Request part number
O/o	Cmd	79/111	4F/6F	Toggle the Display power (On/Off)
P	Rsp	80	50	A character for power status of the Display device follows
Q/q	Cmd	81/113	51/71	Query Software Version - show PC & SC version numbers
R/r	Cmd	82/114	52/72	Toggle the RGB mute for the Switcher only
S/s	Cmd	83/115	53/73	Toggle the Display mute (On/Off)
S	Rsp	83	53	A character for mute status of the Display device follows
T	Rsp	84	54	A character for video signal Type follows
V	Rsp	86	56	A character for the Video channel follows
X	Cmd	88	58	Executive Mode On
x	Cmd	120	78	Executive Mode Off
Z	Cmd	90	5A	Audio mute On
z	Cmd	122	7A	Audio mute Off
[	Cmd	91	5B	Turn the Display power On
]	Cmd	93	5D	Turn the Display power Off

**Simple Instruction Examples**

The tables that follow give examples of some of the ASCII codes that may be entered from a host device. The Switcher Response column shows what will be seen on the host's screen. Appropriate response messages are also displayed on the System 4*xj*'s LCD screen.

The resultant changes made by these commands will also show on the System 4*xj* Front Panel. Errors may occur under certain conditions, such as when trying to select a nonexistent channel, or trying to mute the projector when it is turned off, etc. Error codes are on the next page.

The first group lists commands for the display device (projector/monitor) and the second group lists commands for the switcher (System 4*xj*). The Hex column gives hexadecimal equivalents for cases where the codes will be generated by another source.

Display Commands	ASCII	Hex	Switcher Response	Result Description
Display Power (toggle On) (If switcher was Off, it will also turn On.)	O/o	4F/6F	↓PR·1↓ ↓PW·I↓ ↓PW·E↓	Display Power is On Please Wait, Initializing Please Wait, End
Display Power (toggle Off)	O/o	4F/6F	↓PR·0↓	Display Power is Off
Display Power On (discrete) (If switcher was Off, it will also turn On.)	[	5B	↓PR·1↓ ↓PW·I↓ ↓PW·E↓	Display Power is On Please Wait, Initializing Please Wait, End
Display Power Off (discrete)	]	5D	↓PR·0↓	Display Power is Off
Display Mute (toggle)	S/s	53/73	↓MUT·1↓ ↓MUT·0↓	Display Mute turned On Display Mute turned Off
Display Mute On (discrete)	(	28	↓MUT·1↓	Display Mute is On
Display Mute Off (discrete)	)	29	↓MUT·0↓	Display Mute turned Off

Switcher Commands	ASCII	Hex	Switcher Response	Result Description
Switcher Power On (discrete) (does not affect display device)	<	3C	↓SYS·1↓ Vn↓ An↓	Switcher (System) power is On n = the Video channel number selected n = the Audio channel number selected
Switcher Power Off (discrete) (also turns display Off)	>	3E	↓SYS·0↓ ↓PR·0↓	Switcher (System) power is Off Display power is Off
Switcher RGB Mute (toggle) or Switcher RGB Mute On (discrete) Switcher RGB Mute Off (discrete)	R/r B b	52/72 42 62	↓BLK1↓ ↓BLK0↓ ↓BLK1↓ ↓BLK0↓	Switcher RGB mute On (Blanked) Switcher RGB mute Off Switcher RGB mute is On (Blanked) Switcher RGB mute is Off
Switcher Audio Mute (discrete) Switcher Audio Mute (discrete) Audio Mute On (discrete) Audio Mute Off (discrete)	Z z + -	5A 7A 2B 2D	↓AMUT·1↓ ↓AMUT·0↓ ↓AMUT·1↓ ↓AMUT·0↓	Switcher Audio Mute is On Switcher Audio Mute is Off Switcher Audio Mute is On Switcher Audio Mute is Off
Executive Mode (discrete) Executive Mode (discrete) Executive Mode On (discrete) Executive Mode Off (discrete)	X x : ;	58 78 3A 3B	↓EXE·1↓Vn↓An↓ ↓EXE·0↓Vn↓An↓ ↓EXE·1↓Vn↓An↓ ↓EXE·0↓Vn↓An↓	Switcher is in Executive Mode Switcher <b>not</b> in Executive Mode Switcher is in Executive Mode Switcher <b>not</b> in Executive Mode (Where n = Video channel and/or Audio channel selected)
Request Projector Configuration	C/c	43/63	↓CONFIG·FOR·SONY.....↓ (Total of 24 information/space characters)	Display internal setting for projector type
Request Part Number	N/n	4E/6E	↓60-155-01↓	Part number for the System 4 <i>xj</i> model. (Example is for System 4LD <i>xj</i> )



Switcher Commands	ASCII	Hex	Switcher Response	Result Description
Freeze On	F	46	↓Frz1.↓	Freeze video frame
Freeze Off	f	66	↓Frz0.↓	Release Freeze mode
Demo On	J	4A	↓Dmo1.↓	Demo Mode status = On
Demo Off	j	6A	↓Dmo0.↓	Demo Mode status = Off
Information Request	I/i	49/69	↓V3·A2·T8·P1·S0·Z0·R0·QPC3.0·QSC3.0·M4.↓	This example says: Video channel selected is #3 (V3), Audio channel is #2 (A2), selected input is RGBLD-still (T8), Projector is On (P1), all Mutes {Display (S0), Audio (Z0) & RGB (R0)} are Off, both the Projector software and the Switcher software are version 3.0 (QPC3.0·QSC3.0), and the system has four input channels (M4).
Information Request, example #2:	I/i	49/69	↓V0·A0·T0·P0·S0·Z0·R0·QPC3.0·QSC3.0·M4.↓	This example says that this is a System 4 <sub>xi</sub> with four inputs and its power is turned Off.

Information	ASCII	Hex	Switcher Response	Result (See below)
-------------	-------	-----	-------------------	--------------------

Request Info I 49/69 ↓V[x1]·A[x2]·T[x3]·P[x4]·S[x5]·Z[x6]·R[x7]·QPC[x8]·[x9]·QSC[xa]·[xb]·M[xc]↓

The response on the screen will consist of ten sets of characters with a space (·) between each set. Each set is made up of a letter (or letters) that define a function, followed by a number (or numbers) that define the status of that function. Numbers are represented by [x1], [x2], etc. Examples follow.

Function Character(s)	Status Character(s)
V = Video Channel	[x1] = Video channel # (0 = System power is off)
A = Audio Channel	[x2] = Audio channel # (0 = System power is off)
T = Video Type	System 4 <sub>xi</sub> : LD <sub>xi</sub> __ LQ <sub>xi</sub>
[x3] = 1 = RGBS	x ____ x
2 = Sync on Green (RGsB)	x ____ x
3 = VID	- ____ -
4 = YC	- ____ -
5 = RGBLD (line-doubled RGB)	- ____ -
6 = VIDLD (line-doubled composite video)	- ____ -
7 = YCLD (line-doubled S-video)	- ____ -
8 = RGBLD -still	x ____ -
9 = RGBLD - motion	x ____ -
10 = YCLD - still	x ____ -
11 = YCLD - motion	x ____ -
12 = VIDLD - still	x ____ -
13 = VIDLD - motion	x ____ -
14 = RGBLQ -still	- ____ x
15 = RGBLQ - motion	- ____ x
16 = YCLQ - still	- ____ x
17 = YCLQ - motion	- ____ x
18 = VIDLQ - still	- ____ x
19 = VIDLQ - motion	- ____ x
P = Display Power	[x4] = 0 = Power is Off; 1 = Power is On.
S = Display Mute	[x5] = 0 = Display Mute is Off; 1 = Display Mute is On.
Z = Audio Mute	[x6] = 0 = Audio Mute is Off; 1 = Audio Mute is On.
R = RGB Mute	[x7] = 0 = RGB Mute is Off; 1 = RGB Mute is On.
QPC = Query Projector Comm	[x8]·[x9] = Projector Communications software version (example: 3.0)
QSC = Query Switcher	[xa]·[xb] = Switcher Communications software version (example: 3.0)
M = System Max Channel	[xc] = Maximum channel number

Error Codes	Description
↓E01↓	Invalid Channel # (may be too high)
↓E04↓	Projector Comm error (projector may be off)
↓E05↓	Switcher is Off, can't execute command.
↓E10↓	Invalid command

**Selecting Inputs Using Delimiters**

When selecting inputs to the projector, or display (Dsp) and/or the System 4*x*i switcher (Sw), audio and video can be switched together (follow) or separately (breakaway). An input is selected by its ASCII number, followed by a delimiter character. The delimiter ends the command and also determines which inputs (audio/video) are affected. System 4*x*i delimiters are listed and explained below. There are four delimiters that affect the System 4*x*i. They are:

- ! Affects Audio & Video (Aud/Vid) for the switcher (Sw) and affects only video for the projector (Dsp/Sw)
- @ Affects Audio and Video (Aud/Vid) for switcher only (Sw)
- \$ Affects Audio only (Aud) for the switcher (Sw)
- & Affects Video only (Vid) for both projector and switcher (Dsp/Sw)

Examples:	Aud/Vid	Dsp/Sw	ASCII	Hex	Response	Result Description
Select Input 2	Aud,Vid	*Dsp,Sw	2!	32,21	↵C2↵	Channel 2 selected
Select Input 16	Aud,Vid	*Dsp,Sw	16!	31,36,21	↵C16↵	Channel16 selected
Select Input 2	Aud,Vid	*Sw	2@	32,40	↵C2↵	Channel 2 selected
Select Input 16	Aud,Vid	*Sw	16@	31,36,40	↵C16↵	Channel 16 selected
Select Input 2	Aud	*Sw	2\$	32,24	↵A2↵	Audio Ch 2 selected
Select Input 16	Aud	*Sw	16\$	31,36,24	↵A16↵	Audio Ch 16 selected
Select Input 3	Vid	Dsp,Sw	3&	33,26	↵V3↵	Video Ch 3 selected
Select Input 15	Vid	Dsp,Sw	15&	31,35,26	↵V15↵	Video Ch 15 selected

*\* Audio switching affects only the System 4*x*i and not the display device.*

## Advanced Instruction Set

The Advanced Instruction Set uses commands that are longer than one character because they are more complex than the Simple Instructions described earlier. Advanced Instructions can be used in programs that may be stored and executed as needed.

The system sees the RS-232 information in two general categories:

If bit 7 = 0 (00h - 7Fh), this byte is an instruction.

If bit 7=1 (80h - FFh), it is considered to be data, or information.

However, only certain codes are used by the System 4*xj*.

The components of an Advanced Instruction are:

Escape Code (ESC) - to indicate the start of command

Command Code - to tell the switcher what to do

Subcom - Data (if required) – as many bytes as required for parameters to supplement the Command Code

End Of Transmission (EOT) - to indicate the end of this command

Switcher response to the command:

Escape Code (ESC) - to indicate the start of a response

Command Code - repeated to identify what the response is for

Error Code (ERC) - to indicate no error, or what type of error

Data (if required) - to give the host what was requested

End Of Transmission (EOT) - to indicate the end of the response

The command protocol is as follows:

ESC, Command1, Subcommand1.1, Subcommand1.2, etc... EOT

## Advanced Instruction List

The commands listed here are Advanced Instructions, however, they can be intermixed with commands from the Simple Instruction Set.

Command	Hex	Description
CMD4	34h	Select input channels (audio and video)
CMD5	35h	Request system status
CMD6	36h	Adjust settings (incremental)
CMD8	38h	Set up System 4 <i>xj</i> for slave configuration
CMD9	39h	Configure an input channel
CMD10	3Ah	Request input channel configuration
CMD11	3Bh	Configure system
CMD12	3Ch	Request system configuration

(These are command characters, because they are in the range of 00h - 7Fh.)

## Error Codes (ERC)

An ERC character is included with each response from the System 4*xj*.

Here are the codes for the ERC character used by the System 4*xj*:

80h = No error

81h = Invalid channel

82h = Command not recognized (illegal command)

84h = Projector communication error

85h = Switcher is Off, cannot execute the command

8Ah = Invalid command

8Dh = Invalid parameter value

(These are data characters, because they are in the range of 80h - FFh.)

### Hex, Decimal and Binary Examples for Converting Range Values

1. The Audio range is C1h to FFh for -31dB to +31dB and 31dec = 1Fh.  
To calculate the mid-range (zero dB) add 31d to the low number.  
C1h = 1100 0001bin = -31dec = low end of range  
1Fh = 0001 1111bin = 31dec = half of range  
E0h = 1110 0000bin = 00dec = mid-range (zero) value

To set Audio to +10dB, add 10d (0Ah) to the mid-range (zero) value.  
E0h = 1110 0000bin = 00dB  
0Ah = 0000 1010bin = 10dec  
EAh = 1110 1010bin = +10dB

2. The picture control range is 81h to FFh for -63 to +63 and 63dec = 3Fh.  
To calculate the mid-range (zero setting) add 31dec to the low number.  
81h = 1000 0001bin = -63dec = low end of range  
3Fh = 0011 1111bin = 63dec = half of range  
C0h = 1100 0000bin = 00dec = mid-range value (zero)

To set a picture control to -10, add 53d (63d - 10d) to the low end.  
81h = 1000 0001bin = -63 = low end of range  
0Ah = 0011 0101bin = 53 = 63 - 10dec  
B6h = 1011 0110bin = -10 = new setting



*This is one example of how it can be done. You could also subtract 10d (0Ah) from the mid-range value.*

### Select Input - CMD4 (34h)

CMD4 is for selecting video and audio input channels. The flexibility of this command is that it allows for selection of audio and video from separate channels (Breakaway mode) or from the same channel (Audio Follow).

By using a "no change" parameter it can be used to select either audio or video, without changing the other. The command can also specify System 4<sub>xi</sub> only, or System 4<sub>xi</sub> and the display device. The range of channel numbers is 1 thru 22.

Format: ESC, CMD4, Subcom4.1, Vid#, Aud#, EOT

Where: ESC, CMD4 = 1Bh, 34h

Subcom4.1    80h = System 4<sub>xi</sub> affected  
                  81h = System 4<sub>xi</sub> and Projector affected  
Vid#         80h = No changes  
                  81h = Video input #1  
                  82h = Video input #2  
                  83h = Video input #3  
                  etc.  
                  96h = Video input #22 (highest number)  
Aud#         80h = No changes  
                  81h = Audio input #1  
                  82h = Audio input #2  
                  83h = Audio input #3  
                  etc.  
                  96h = Audio input #22 (highest number)  
EOT = 04h = End of transmission

Example: Select Switcher Video input #17 and Audio input #3  
1Bh, 34h, 80h, 91h, 83, 04h

*Note: Input numbers are in hexadecimal (91h = 1001 0001bin = 145d).*

Response: ESC, CMD4, ERC, EOT

**Request Status - CMD5 (35h)**

To get Video Mode information for another channel, do a CMD4 to change input channels, and then do CMD5 again, or use CMD10.

This command requests the current system status. Because the command is asking for something, there is no need for any other parameters. The channel-related information is only for the channel that is currently selected.

Format: ESC, CMD5, EOT

Example: 1Bh, 35h, 04h

Response: ESC, CMD5, ERC, Vid#, Aud#, Vid Mode, Dsp Type, Dsp Pwr, Dsp Mute, Sys Pwr, Max Chnl, Dly Time, EOT

Where: ESC, CMD5 = 1Bh, 35h

ERC (See list.)

Vid# 81h - 96h = currently selected video channel

Aud# 81h - 96h = currently selected audio channel

Vid Mode on System 4<sub>xi</sub>: \_\_\_\_\_ LD<sub>xi</sub> LQ<sub>xi</sub>  
 80h = RGSB (composite sync) \_\_\_\_\_ x \_\_\_ x  
 81h = RGSB (sync on green) \_\_\_\_\_ x \_\_\_ x  
 82h = RGBLD (line-doubled RGB video) \_\_\_ - \_\_\_ -  
 83h = YC (S-video) \_\_\_\_\_ - \_\_\_ -  
 84h = VID (composite video) \_\_\_\_\_ - \_\_\_ -  
 85h = YCLD (line-doubled S-video) \_\_\_\_\_ - \_\_\_ -  
 86h = VIDLD (line-doubled composite video) - \_\_\_ -  
 87h = RGBLD - still \_\_\_\_\_ x \_\_\_ -  
 88h = RGBLD - motion \_\_\_\_\_ x \_\_\_ -  
 89h = YCLD - still \_\_\_\_\_ x \_\_\_ -  
 8Ah = YCLD - motion \_\_\_\_\_ x \_\_\_ -  
 8Bh = VIDLD - still \_\_\_\_\_ x \_\_\_ -  
 8Ch = VIDLD - motion \_\_\_\_\_ x \_\_\_ -  
 8Dh = RGBLQ - still \_\_\_\_\_ - \_\_\_ x  
 8Eh = RGBLQ - motion \_\_\_\_\_ - \_\_\_ x  
 8Fh = YCLQ - still \_\_\_\_\_ - \_\_\_ x  
 90h = YCLQ - motion \_\_\_\_\_ - \_\_\_ x  
 91h = VIDLQ - still \_\_\_\_\_ - \_\_\_ x  
 92h = VIDLQ - motion \_\_\_\_\_ - \_\_\_ x

Dsp Type 80h = Ampro  
 81h = RS-232 only (no display device)  
 82h = Barco  
 83h = Sony (or Mitsubishi XC monitor)  
 84h = ECP (3100 & 4100)  
 85h = Hughes/JVC  
 86h = Marquee  
 87h = NEC/Runco  
 88h = Mitsubishi VS  
 89h = Panasonic 1083U/1085U  
 8Ah = Toshiba  
 8Bh = Ampro LCD 150  
 8Ch = Seleco  
 8Dh = Digital Projection  
 8Eh = Zenith Pro Series  
 8Fh = Ampro Exe mode  
 90h = NEC LCD (MT)  
 92h = Panasonic 1083UN/1085UN  
 93h = Sharp LCD  
 94h = NEC XG  
 96h = Mitsubishi LCD 100/200  
 97h = Infocus (CLI RS-232)  
 98h = Hughes/JVC G1000  
 99h = Sharp LCD, RS-232  
 9Eh = Electrohome 1024

Dsp Power 80h = Display device power is Off  
81h = Display device power is On  
Dsp Mute 80h = Mute Off (picture on)  
81h = Mute On (picture off)  
Sys Pwr 80h = System 4<sub>xi</sub> power is Off  
81h = System 4<sub>xi</sub> power is On  
Max Chnl 80h - 96h (maximum number of inputs on system)  
Dly Time 80h - 8Ah (RGB time delay in half seconds)  
EOT 04h = End of transmission

Response example:

1Bh, 35h, 80h, 82h, 81h, 83h, 85h, 81h, 80h, 81h, 84h, 85h, 04h

Translates to:

ESC, CMD5, ERC, Video Channel #2, Audio Channel #1, S-Video mode, Hughes projector, Dsp Power is On, Dsp Mute is Off, System Power is On, Max channel # is 4, and the RGB time delay is 2.5 seconds.

### **Change System Settings - CMD6 (36h)**

Change settings, and/or make adjustments to the system. This command allows incremental adjustments to be made to System 4<sub>xi</sub> settings, for the currently-selected input channel.

Format: ESC, CMD6, Subcom6.1, Subcom6.2, EOT

Where: ESC, CMD6 = 1Bh, 36h

Subcom6.1 = Function to adjust  
80h = Horizontal Shift  
81h = Contrast  
82h = Color  
83h = Tint (Hue)  
84h = Audio level  
85h = RGB time delay (0.5 second steps)  
Subcom6.2 = How much to adjust  
80h = Adjust up 1 step  
81h = Adjust down 1 step

Example: Adjust Audio level down = 1Bh, 36h, 84h, 81h, 04h

Response: ESC, CMD6, ERC, EOT



*This command is optimized to be used as an audio fader control for systems which require this feature.*

### **Set Slave Configuration - CMD8 (38h)**

Set up the System 4<sub>xi</sub> for slave configuration. The System 4<sub>xi</sub> can have another type of switcher connected to input channel 4 as a slave. In order to communicate with the slave, the System 4<sub>xi</sub> must know what type of switcher is being used.

Format: ESC, CMD8, Slave, EOT

Where: ESC, CMD8 = 1Bh, 38h

Slave 80h = No slave connected  
84h = SW4MX switcher connected  
86h = SW6MX switcher connected  
88h = System 8 Plus switcher connected  
8Ah = System 10 Plus switcher connected  
8Fh = Multiple System 8/10 Plus switchers

Response: ESC, CMD8, ERC, EOT

### Configure an Input Channel - CMD9 (39h)

Send a preset configuration to the System 4<sub>xi</sub> to set up an input channel.

Format:

ESC, CMD9, Inp#, Vid Mode, Aud Lvl, H Shift, Cont, Color, Tint, Chroma Det, Luma Det, reserved, EOT

Where: ESC, CMD9 = 1Bh, 39h

Inp#            80h = current channel  
                   81h - 96h = Input channel 1-22

Vid Mode on System 4 <sub>xi</sub> :	_____	LD <sub>xi</sub>	LQ <sub>xi</sub>
FFh = No change	_____	x	x
80h = RGBS (composite sync)	_____	x	x
81h = RGSB (sync on green)	_____	x	x
82h = RGBLD (line-doubled RGB video)	_____	-	-
83h = YC (S-video)	_____	-	-
84h = VID (composite video)	_____	-	-
85h = YCLD (line-doubled S-video)	_____	-	-
86h = VIDLD (line-doubled composite video)	_____	-	-
87h = RGBLD - still	_____	x	-
88h = RGBLD - motion	_____	x	-
89h = YCLD - still	_____	x	-
8Ah = YCLD - motion	_____	x	-
8Bh = VIDLD - still	_____	x	-
8Ch = VIDLD - motion	_____	x	-
8Dh = RGBLQ - still	_____	-	x
8Eh = RGBLQ - motion	_____	-	x
8Fh = YCLQ - still	_____	-	x
90h = YCLQ - motion	_____	-	x
91h = VIDLQ - still	_____	-	x
92h = VIDLQ - motion	_____	-	x

Aud Lvl <sup>2</sup>	C1h - FFh = Audio level (-31dB to +31dB)
H Shift <sup>2</sup>	81h - FFh = Horizontal shift (-63 to +63 in steps of 2)
Cont <sup>2</sup>	81h - FFh = Contrast level (-63 to +63 in steps of 2)
Color <sup>2</sup>	81h - FFh = Color level (-63 to +63 in steps of 2)
Tint <sup>2</sup>	81h - FFh = Tint level (-63 to +63 in steps of 2)
Chroma Det <sup>4</sup>	80h = No change 81h = On 82h = Off
Luma Det <sup>5</sup>	80h = No change 81h-84h = Decoded-modes Sharpness levels 1 - 4
reserved	80h = reserved
EOT	04h = End Of Transmission

Notes:

2. For Audio Level and Picture Control settings, 80h = no change. See page A-8 for examples for calculating these values.

4. Only available in System 4<sub>xi</sub> units with the following firmware revision levels, or higher:

5. Only available on System 4LD<sub>xi</sub> and 4LQ<sub>xi</sub>

**Request Input Channel Configuration - CMD10 (3Ah)<sup>4</sup>**

Request the configuration for a specific input channel in the System 4<sub>xi</sub>.

Format:

ESC, CMD10, Inp#, EOT

Response: ESC, CMD10, ERC, Vid Mode, Aud Lvl, H Shift, Cont, Color, Tint, Chroma Det, Luma Det, reserved, EOT

Where: ESC, CMD10 = 1Bh, 3Ah

Inp#            80h = Request current channel  
                   81h - 96h = Input channel requested (1-22)

Vid Mode on System 4<sub>xi</sub>: \_\_\_\_\_ LD<sub>xi</sub> \_ LQ<sub>xi</sub>

80h = RGSB (composite sync)	_____	x	___	x
81h = RGSB (sync on green)	_____	x	___	x
82h = RGLD (line-doubled RGB video)	_____	-	___	-
83h = YC (S-video)	_____	-	___	-
84h = VID (composite video)	_____	-	___	-
85h = YCLD (line-doubled S-video)	_____	-	___	-
86h = VIDLD (line-doubled composite video)	_____	-	___	-
87h = RGLD - still	_____	x	___	-
88h = RGLD - motion	_____	x	___	-
89h = YCLD - still	_____	x	___	-
8Ah = YCLD - motion	_____	x	___	-
8Bh = VIDLD - still	_____	x	___	-
8Ch = VIDLD - motion	_____	x	___	-
8Dh = RGLQ - still	_____	-	___	x
8Eh = RGLQ - motion	_____	-	___	x
8Fh = YCLQ - still	_____	-	___	x
90h = YCLQ - motion	_____	-	___	x
91h = VIDLQ - still	_____	-	___	x
92h = VIDLQ - motion	_____	-	___	x

Aud Lvl	C1h - FFh = Audio level (-31dB to +31dB)
H Shift	81h - FFh = Horizontal shift (-63 to +63 in steps of 2)
Cont	81h - FFh = Contrast level (-63 to +63 in steps of 2)
Color	81h - FFh = Color level (-63 to +63 in steps of 2)
Tint	81h - FFh = Tint level (-63 to +63 in steps of 2)
Chroma Det	81h = On 82h = Off 83h = not supported
Luma Det <sup>6</sup>	81h-84h = Decoded-modes Sharpness levels 1 - 4 80h = not supported
reserved	80h = reserved
EOT	04h = End Of Transmission

Notes:

4. This command is only available in System 4<sub>xi</sub> units with the following firmware revision levels, or higher:  
 System 4LD<sub>xi</sub> – revision 3.0  
 System 4LQ<sub>xi</sub> – revision 4.0

6. Only available on System 4LD<sub>xi</sub> and 4LQ<sub>xi</sub>.

Example:

Request Configuration for Input Channel #4:  
 1Bh, 3Ah, 84h, 04h

Response example:

Input #4 is configured for line-doubled S-video (motion), Audio at 0dB and all picture controls (H Shift, Contrast, Color and Tint) at mid-range (zero), Chroma Detail (not applicable), Luma Detail at level 1.

This would be:

1Bh, 3Ah, 80h, 8Ah, E0h, C0h, C0h, C0h, C0h, 82h, 81h, 80h 04h



### Configure System - CMD11 (3Bh)<sup>4</sup>

Configure the System 4*xj*

Format:

ESC, CMD11, LD Sync, RGB Delay, Aud Mute, reserved, LD*xj* Misc, reserved, EOT

Where: ESC, CMD11 = 1Bh, 3Bh

LD Sync      80h = no change  
                  81h = Composite Sync with no serrations  
                  82h = Sync negative (horizontal & vertical)  
                  83h = Composite Sync with serrations  
                  84h = <sup>6</sup>Sync positive (horizontal & vertical)  
                  85h = <sup>6</sup>Sync positive horizontal, negative vertical  
                  86h = <sup>6</sup>Sync negative horizontal, positive vertical

RGB Delay    FFh = no change  
                  80h - 8Ah = RGB Delay in 0.5 second steps  
    (values range from 0 to 5 seconds)

Audio Mute    80h = Turn Audio Mute Off  
                  81h = Turn Audio Mute On  
                  FFh = No change

LD*xj* Misc<sup>6</sup>    80h - AAh (see table)

	Bit #s	76	54	32	10	
Function:	-	Demo	Freeze	VGA		
No changes	10	00	00	00	80h	
Demo, no change	10	00	xx	xx	8xh	
Demo mode On	10	01	xx	xx	9xh	
Demo mode Off	10	10	xx	xx	Axh	
Freeze no change	10	xx	00	xx		
Freeze On	10	xx	01	xx		
Freeze Off	10	xx	10	xx		
VGA no change	10	xx	xx	00		
Not VGA resolution	10	xx	xx	01		
Force VGA resolution	10	xx	xx	10		

reserved      80h = reserved

EOT            04h = End Of transmission

Example:

Configure a System 4*xj* for the following:

Sync = No change, RGB Delay = No change, Audio Mute = On, Demo Mode = No change, Freeze = No change and Force VGA Resolution = No change.

That is: 1Bh, 3Bh, 80h, FFh, 81h, 80h, 80h, 80h, 04h

Normal response:

ESC, CMD11, ERC, EOT

1Bh, 3Bh, 80h, 04h

Notes:

4. This command is only available in System 4*xj* units with the following firmware revision levels, or higher:  
 System 4LD*xj* – revision 3.0  
 System 4LQ*xj* – revision 4.0

6. Only available on System 4LD*xj* and 4LQ*xj*

**Request System Configuration - CMD12 (3Ch)<sup>4</sup>**

Request the System 4<sub>xj</sub> Configuration.

Format:  
ESC, CMD12, EOT

Response:  
ESC, CMD12, ERC, LD Sync, RGB Delay, Aud Mute, Status 1, LD<sub>xj</sub> Misc, reserved, EOT

Where: ESC, CMD12 = 1Bh, 3Ch

LD Sync     81h = Composite Sync with no serration pulses

              82h = Sync negative (horizontal & vertical)

              83h = Composite Sync with serration pulses

              84h = <sup>6</sup>Sync positive (horizontal & vertical)

              85h = <sup>6</sup>Sync positive horizontal, negative vertical

              86h = <sup>6</sup>Sync negative horizontal, positive vertical

RGB Delay   80h - 8Ah = RGB Delay in 0.5 second steps  
                                (values range from 0 to 5 seconds)

Aud Mute     80h = Audio is not Muted

              81h = Audio is Muted

Status 1     80h - 83h (See table below.)

	Bit #	7-6-5-4-3-2	1	0
Function:			Sys Power	Model
Power is Off		1-0-0-0-0-0	0	x
Power is On		1-0-0-0-0-0	1	x
Sys 4C		1-0-0-0-0-0	x	1
Sys 4LD, 4LD <sub>ex</sub> , 4LQ <sub>ex</sub>		1-0-0-0-0-1	x	0
Sys 4LD <sub>xj</sub> , 4LQ <sub>xj</sub>		1-0-0-0-0-1	x	0

LD<sub>xj</sub> Misc<sup>6</sup>     80h - AAh (See table.)

	Bit #s	76	54	32	10
Function:	–		Demo	Freeze	VGA
Demo mode On	10	01	xx	xx	
Demo mode Off	10	10	xx	xx	
Freeze On	10	xx	01	xx	
Freeze Off	10	xx	10	xx	
Not VGA resolution	10	xx	xx	01	
Force VGA resolution	10	xx	xx	10	

reserved     80h = reserved

EOT           04h = End Of transmission

Example: (Request System Configuration)

1Bh, 3Ch, 04h

Response:  
1Bh, 3Ch, 80h, 83h, 80h, 81h, 82h, A9h, 80h, 04h

Says: LD Sync = Composite with serration pulses, RGB Delay = none, Audio is Muted, Model = System 4LD<sub>xj</sub>, 4LQ<sub>xj</sub>, Switcher Power = On, Demo Mode = Off, Freeze = Off and VGA Resolution is not forced.

4. This command is only available in System 4<sub>xj</sub> units with the following firmware revision levels, or higher:  
System 4LD<sub>xj</sub> – revision 3.0  
System 4LQ<sub>xj</sub> – revision 4.0

6. Only available on System 4LD<sub>xj</sub> and System 4LQ<sub>xj</sub>

# ***System 4<sub>xi</sub> Switcher Series*** ***User's Manual***

---



## **Appendix B**

### **Reference Information**

***System 4<sub>xi</sub> Related Parts List***

***Changing the Main Fuse***

***Upgrading the Software***

***Backup Battery***

## System 4*xi* Related Parts List

As illustrated below, the System 4*xi* needs two additional parts to control a projector.

1. A Projector Communications Extension Cable (CC Cable)
2. A Communications Adapter (Comm Adapter)

The Communications Extension Cable is the same for all applications, other than the choice of length.

The Projector Comm Adapter connects between the Communications Extension Cable and the projector. It is designed specifically for the projector being used. The connectors used by the Comm Adapter depend on what is required by the projector.

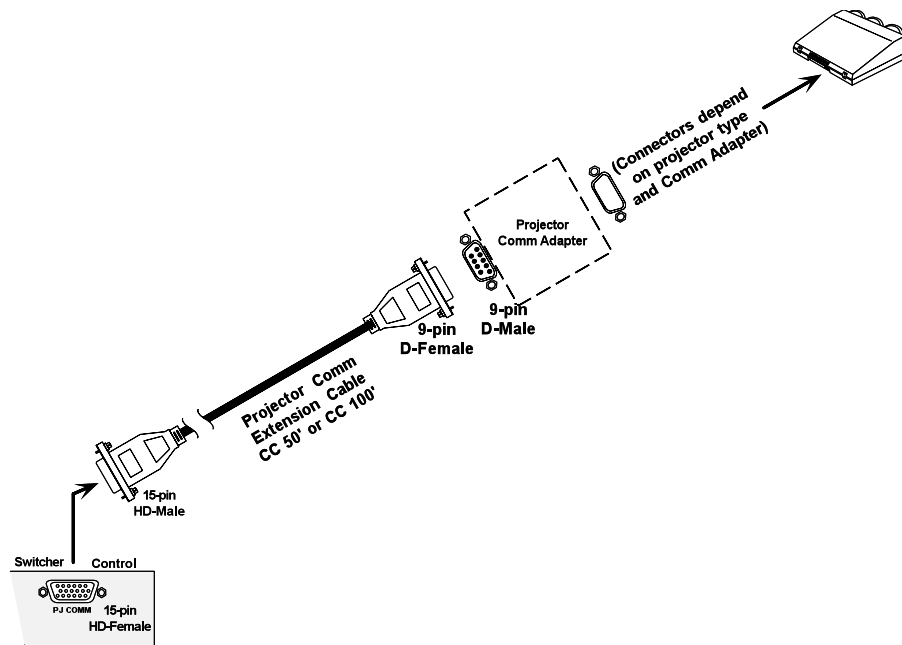



Figure B-1. System 4*xi*-to-Projector Cables and Adapters

Projector Communication Extension Cables	Connectors	Part #
CC 50' (50 ft.)	15/HD/M to 9/D/F	26-305-01
CC 50' Type II (50 ft.)	15/D/M to 15/D/F	26-323-01
CC 100' (100 ft.)	15/HD/M to 9/D/F	26-305-02
CC 100' Type II (100 ft.)	15/D/M to 15/D/F	26-323-02
CC 200' (200 ft.)	15/HD/M to 9/D/F	26-305-03
CC 200' Type II (200 ft.)	15/D/M to 15/D/F	26-323-03
<b>S-Video Adapter Cables</b>		
S-VHS 6' (male-to-male, 6 feet)		26-316-02
S-VHS M20' (male-to-male, 20 feet)		26-316-01
S-VHS BNC (male-to-male, S-video to BNC, 6")		26-353-01
<b>Connectors</b>		
Captive Screw Phoenix Connectors (6-pin, Audio)		10-163-01
<b>Documentation</b>		
System 4 <i>x</i> i User's Manual		68-162-01
System 4 <i>x</i> i Label		33-151-01

## Changing the Main Fuse

 The Main Fuse is located on the Power Supply board. To replace the fuse, remove the AC Power cord and remove the top cover of the System 4*x*i (procedure on page 2-3).

The picture below shows the left-rear corner of the System 4*x*i chassis. Locate the fuse on the Power Supply board.

Remove the fuse from its holder and test it with an ohm meter or other testing device. Replace a bad fuse with a 2 amp, 250v fuse.

If the fuse is not bad, and the unit has no indication of having power, call Extron for instructions on service.

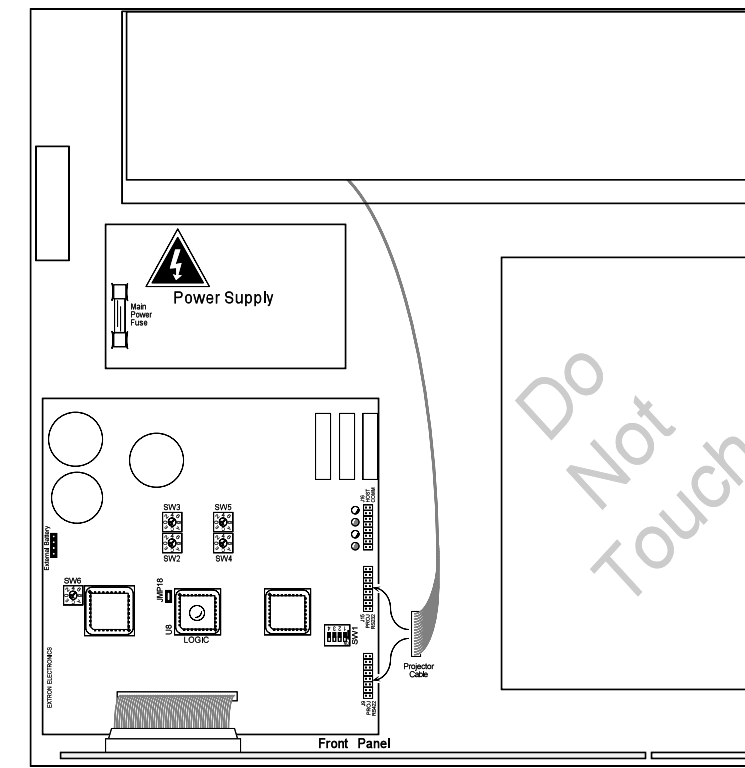

Figure B-2. Locate the Fuse on the Power Supply.

## Les câbles fournis à l'utilisateur

Pour vos installations spécifiques, il vous est possible de choisir vos propres Câbles de Communication pour Projecteur ( CC xx). Utilisez la figure ci-dessous pour réaliser le branchement des Pin. La longueur des câbles peut atteindre 61 mètres (200 feet).

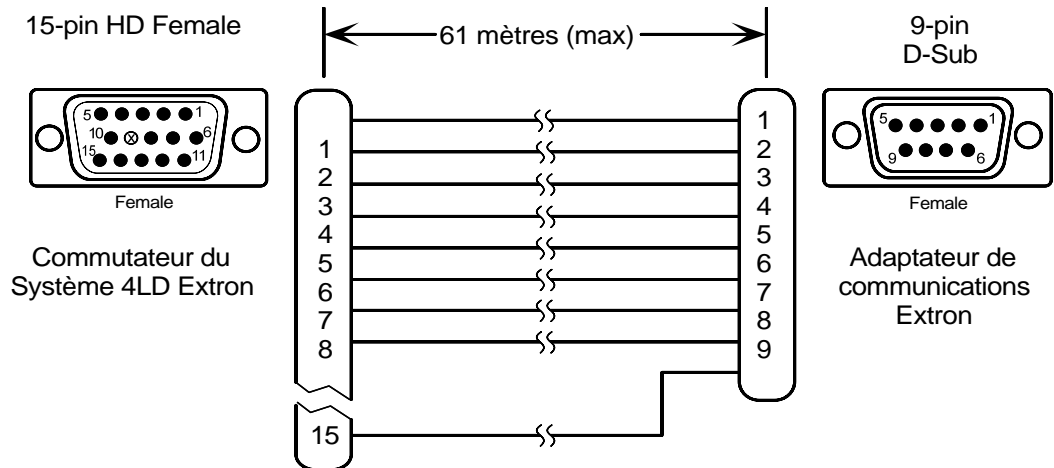
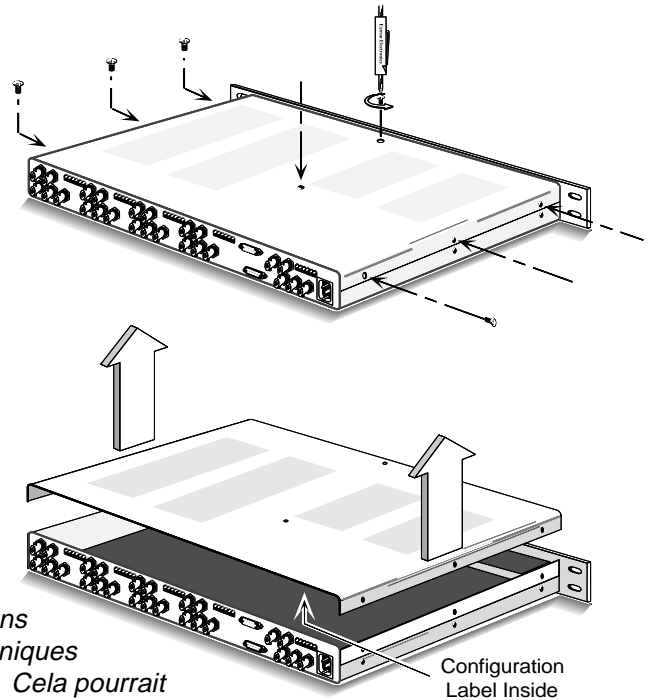

Figure B-3.

## Enlever le couvercle du Système 4*x*i

Si la configuration du Système 4*x*i doit être modifiée pour un différent projecteur, il est nécessaire d'accéder à la carte du Contrôleur Principal. De même, si le fusible de l'alimentation secteur doit être changé, on devra ouvrir l'appareil. Dans les deux cas, vous devez dans un premier temps enlever le couvercle supérieur du Système 4*x*i.

- 1/ Débrancher le cordon d'alimentation.
- 2/ Si le Système 4*x*i est monté en rack, détachez-le.
- 3/ Ôter les câbles d'entrée et de sortie.
- 4/ Mettre le Système 4*x*i sur une surface propre et enlever les 7 vis comme représenté sur la figure.
- 5/ Procéder à l'opération (configuration du système ou changement des fusibles).



*NE PAS toucher les boutons ou les composants électroniques autres que ceux spécifiés. Cela pourrait sérieusement affecter l'opération du système.*

Figure B-4. Enlever le couvercle du Système 4*x*i

- 6/ Quand le travail à l'intérieur du système 4*x*i est terminé, effectuer les opérations dans l'ordre inverse.

## Câbler un Système 4*x*i sur un rack

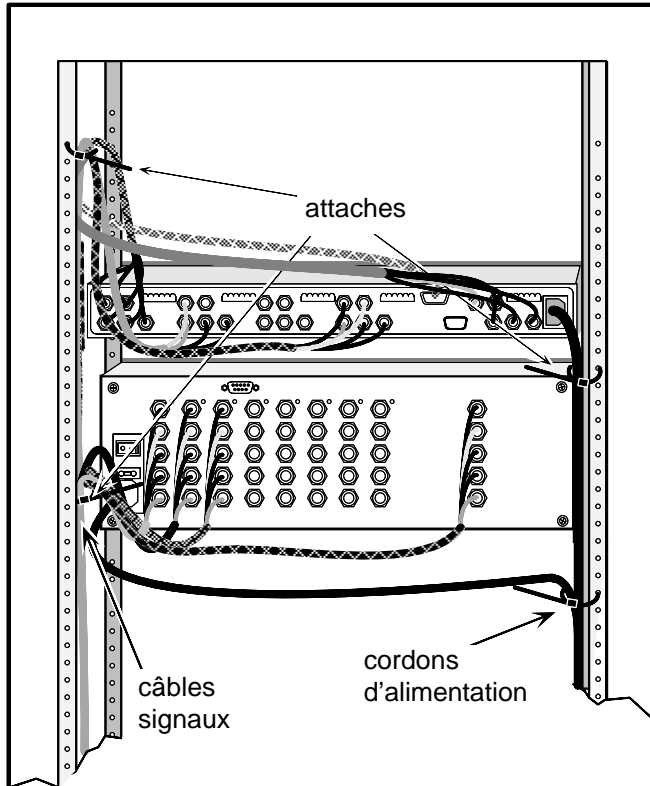

Quand vous fixez les câbles d'une unité à l'autre, veillez à ce que ces câbles ne soient pas "supportés" par le système 4*x*i. Utilisez des attaches de manière à ce que les câbles soient fixés au dessus du panneau de branchement arrière. Tous les câbles non attachés peuvent provoquer des dommages aux utilisateurs, à l'équipement, et également aux câbles eux-mêmes.

L'illustration montre la vue arrière d'un système sur rack. Les câbles sur notre exemple sont fixés sur support au dessus des branchements de l'équipement. Cela permet une vue dégagée des panneaux arrière et évite que les câbles ne tombent sur l'équipement.

**Figure B-5. Les cordons d'alimentation peuvent être mis sur la droite et les câbles signaux sur la gauche.**

- △ ——— Assurez-vous qu'aucun poids sur l'arrière du Système 4*x*i ne dépasse 3.73 Kg. (10 lbs).
- △ ——— Les trous au-dessus et au-dessous du boîtier du Système 4*x*i sont destinés au refroidissement. **NE PAS COUVRIR** ces trous car cela pourrait endommager des composants vitaux.
- △ ——— La température ambiante maximale ne doit pas dépasser 40°C.
- △ ——— Le rack et tout équipement monté sur ce support doivent être branchés selon les normes électriques en vigueur.
-  ——— Si possible, essayer de séparer les cordons de secteur et les câbles signaux.

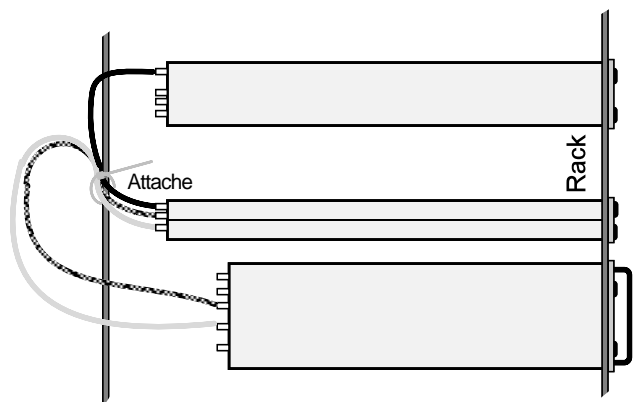

**Figure B-6. Attaches évite que les câbles ne tombent sur l'équipement.**

## Entfernung der System 4*x*i Abdeckung

Die Abdeckung des System 4*x*i muß entfernt werden wenn für eine andere VDU eingerichtet, und dadurch Zugang zum Hauptcontroller benötigt wird, oder wenn die Hauptsicherung ausgetauscht wird.

1. Ziehen Sie den Netzstecker.
2. Falls eingebaut, entfernen Sie System 4*x*i aus dem Gestell.
3. Eingangs- und Ausgangskabel entfernen.
4. Stellen Sie System 4*x*i auf einen sauberen Untergrund und entfernen Sie die acht (8) Schrauben, siehe Abbildung.
5. Arbeiten erledigen.

(Entweder Projektor Konfigurieren oder Sicherung ersetzen.)



*Berühren Sie keine Schalter oder Bauteile außer die, die angegeben wurden. Es könnte sonst ernsthafte Auswirkungen auf das System haben.*

6. Wiederholen Sie die Schritte 1-5 in umgekehrter Reihenfolge um die Abdeckung wieder zu befestigen.

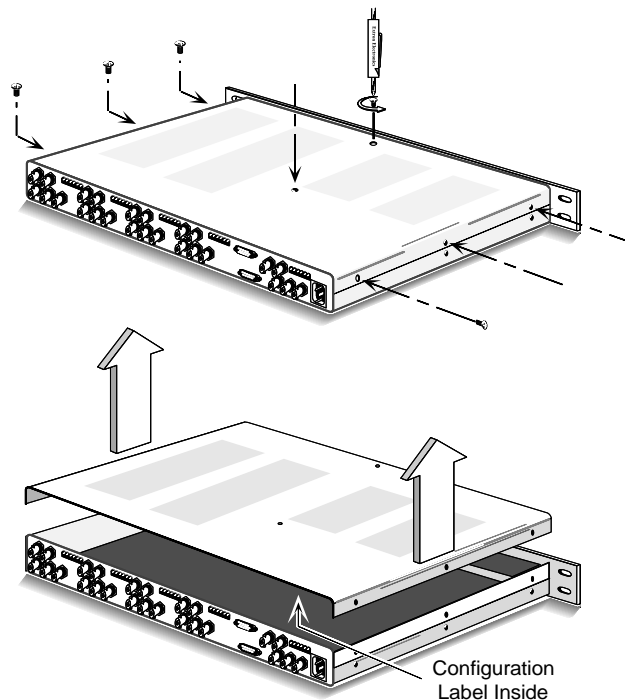
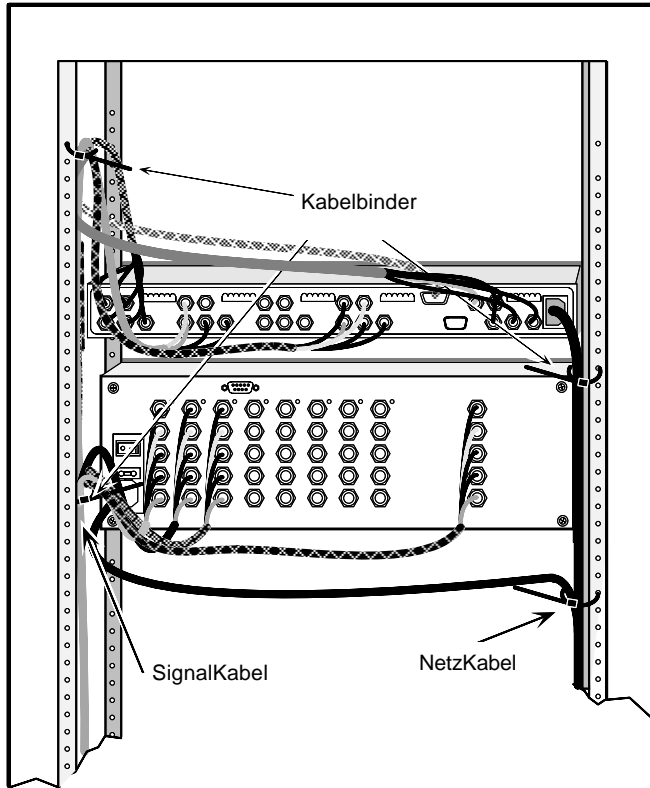

Figure B-7. Entfernung der System 4*x*i Abdeckung



## Verkabelung vom System 4<sub>xi</sub> innerhalb eines Gestells



Wenn Sie Kabel innerhalb eines Gestells von einem Gerät zum anderen verlegen, sollen diese Kabel nicht vom System 4<sub>xi</sub> gehalten werden. (Siehe Figure B-6.)

Verwenden Sie Kabelbinder oder ähnliches um die Kabel an einem Punkt zu befestigen der höher liegt als die Anschlüsse an der Rückseite des Gerätes.

Kabel die lose herabhängen stellen eine Gefahrenquelle für Mensch und Gerät dar.

Die Abbildung zeigt die Rückansicht eines Systemgestells.

Das Beispiel zeigt, daß die Kabel an einem Punkt befestigt sind, der höher liegt als die Anschlüsse an der Rückseite des Gerätes.

Dies ermöglicht eine freie Übersicht der Rückseite und verhindert, daß das Gewicht der Kabel das Gerät belastet.

**Figure B-8. Netzkabel an der rechten Seite und Signalkabel an der linken Seite.**

- △ ————— Vermeiden Sie eine Belastung der System 4<sub>xi</sub> Rückseite von mehr als 3,73 kg.
- △ ————— Die Löcher an der Ober- und Unterseite des System 4<sub>xi</sub> dienen der Kühlung. Bedecken Sie diese Löcher nicht da eine Überhitzung der wichtigen Bauteile erfolgen kann.
- △ ————— Die maximale Umgebungstemperatur beim Betrieb liegt bei 40 Grad °C (104 °F).
- △ ————— Das Gestell, und die sich darin befindlichen Geräte müssen den landesüblichen Bestimmungen entsprechend geerdet werden.
-  ————— Wenn möglich, verlegen Sie die Netz- und Signalkabel getrennt.

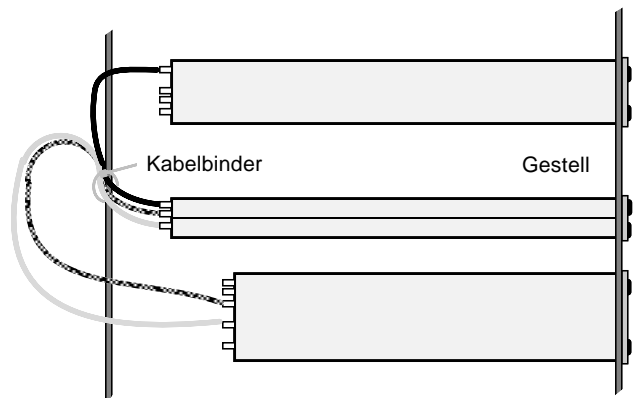
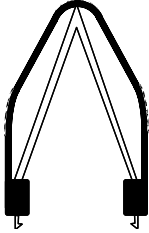

**Figure B-9. Kabelbinder verhinderndaß das Gewicht der Kabel das Gerät belastet.**

## Upgrading Main Controller Board Software and Battery Replacement



This procedure requires removing both AC power as well as the battery backup. If your System 4.xi software is version 1.3 or greater, it may not have a backup battery. For earlier versions with a battery backup, all programs stored in the System 4.xi will be lost.



1. With the System 4.xi cover removed and AC power disconnected, unplug the red/black backup battery cable at the Main Controller board. If there is no backup battery, please disregard this step.
2. **Be sure you are electrically grounded!** Use the PLCC IC puller to remove the old Software chip. Squeeze the tool to align the hooks with the slots provided in opposite corners of chip socket U8. Insert the hooks, squeeze gently and pull the IC straight out of the socket. Set the chip aside.
3. Take the **new** software chip and note the location of the angled corner. Orient this to match the angled corner of the socket U8 and carefully press it into place.
4. For systems with a backup battery, please reconnect the red/black cable to the Main Controller board.

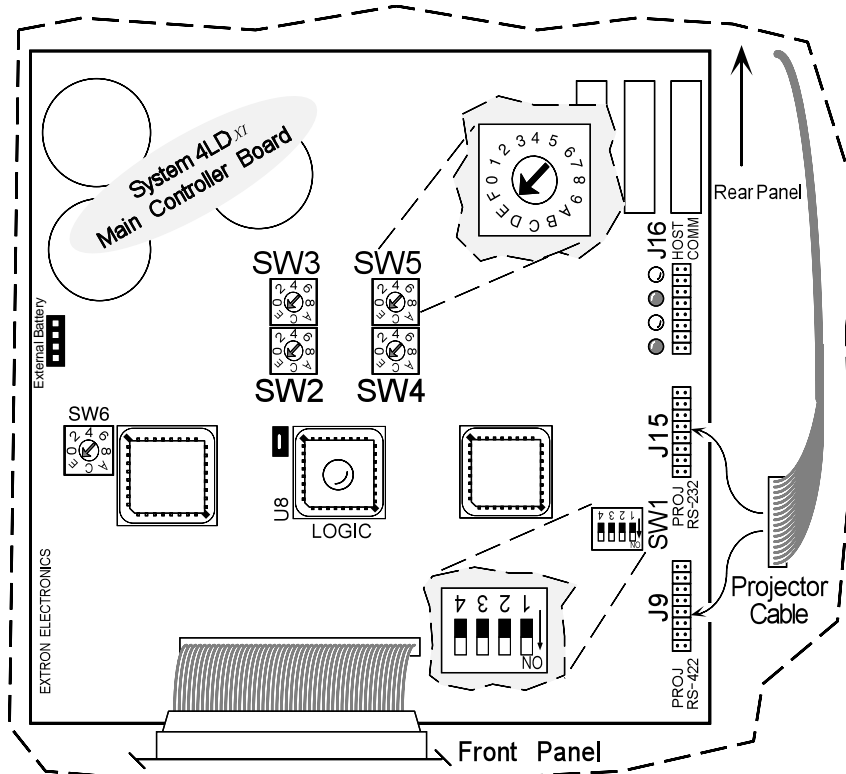

Figure B-10. System 4.xi Main Controller Board



The new software version does not require a backup battery.

5. Reinstall the cover.
6. Connect the AC power cord and apply power to the System 4.xi.



**System 4.xi Lithium Backup Battery • Danger of explosion if battery is incorrectly replaced. Replace only with the same or equivalent type recommended by the manufacturer. Dispose of used batteries according to the manufacturer's instructions.**

## Extron's Warranty

Extron Electronics warrants the product against defects in materials for a period of two years and defect in workmanship for a period of two years from the date of purchase. In the event of malfunction during the warranty period attributable directly to faulty workmanship and/or materials, Extron Electronics will, at its option, repair or replace said products or components, to whatever extent it shall deem necessary to restore said product to proper operating condition, provided that it is returned within the warranty period, with proof of purchase and description of malfunction to:

Extron Electronics  
1230 South Lewis Street  
Anaheim, CA 92805, U.S.A.

This Limited Warranty does not apply if the fault has been caused by misuse, improper handling care, electrical or mechanical abuse, abnormal operating conditions or non-Extron authorized modification to the product.



*If it has been determined that the product is defective, please call Extron and ask for an Applications Engineer at (714) 491-1500 to receive an RA# (Return Authorization number). This will begin the repair process as quickly as possible.*

Units must be returned insured, with shipping charges prepaid. If not insured, you assume the risk of loss or damage during shipment. Returned units must include the serial number and a description of the problem, as well as the name of the person to contact in case there are any questions.

Extron Electronics makes no further warranties either expressed or implied with respect to the product and its quality, performance, merchantability, or fitness for any particular use. In no event will Extron Electronics be liable for direct, indirect, or consequential damages resulting from any defect in this product even if Extron Electronics has been advised of such damage.

Please note that laws vary from state to state, and that some provisions of this warranty may not apply to you.



EXTRON ELECTRONICS / RGB SYSTEMS, INC.  
1230 South Lewis Street, Anaheim, CA 92805  
(800) 633-9876 (714) 491-1500 FAX (714) 491-1517  
U.S.A.

EXTRON ELECTRONICS, EUROPE  
Beeldschermweg 6C, 3821 AH Amersfoort  
+31-33-453-4040 FAX +31-33-453-4050  
The Netherlands

EXTRON ELECTRONICS, ASIA  
41B Kreta Ayer Road, Singapore 089003  
+65-226-0015 FAX +65-226-0019  
Singapore